

DORMER  PRAMET

**NUOVI
PRODOTTI**

2023.1





T9415

QUALITA' CVD DI NUOVA GENERAZIONE

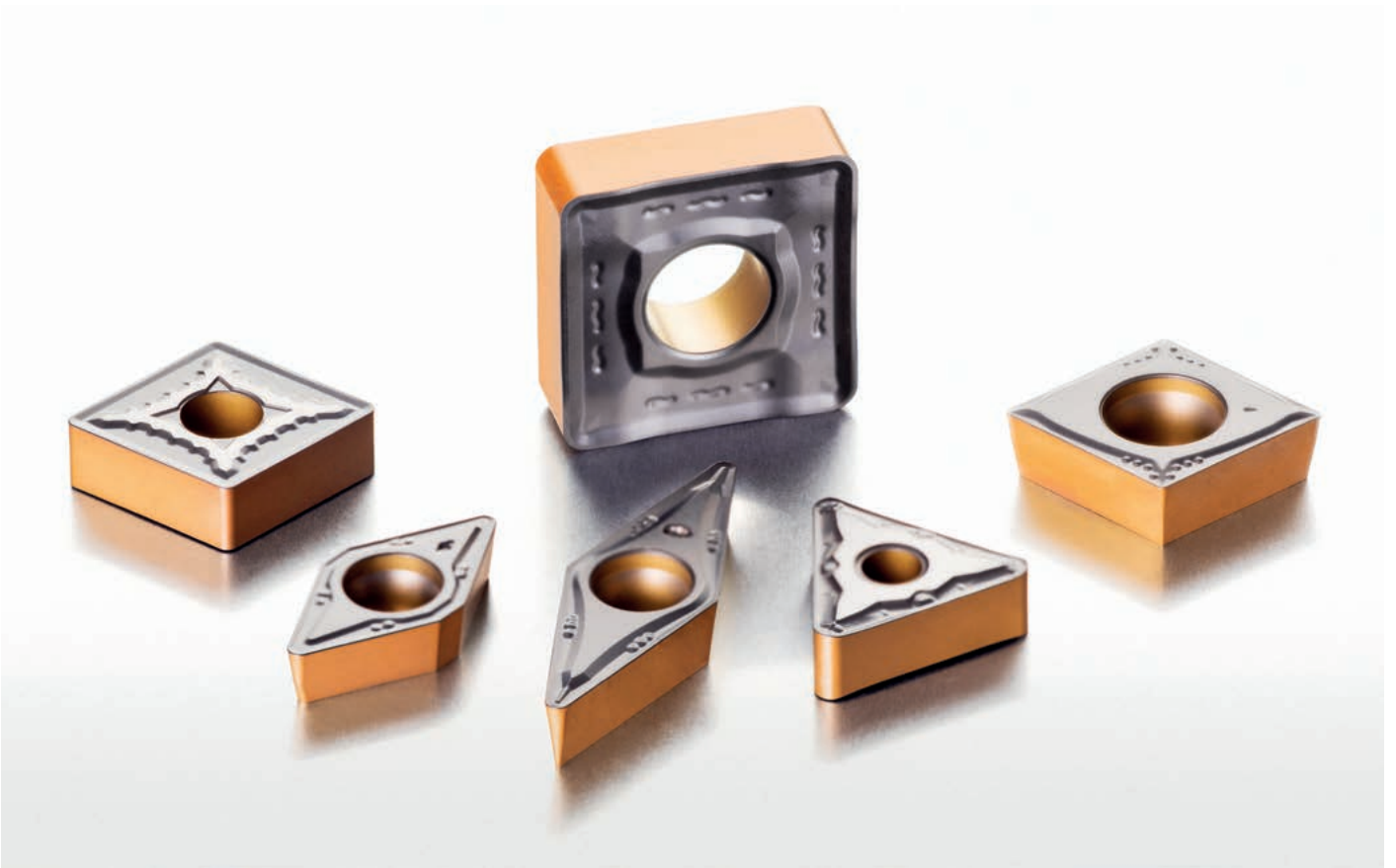

SON06C

**FRESA A SPIANARE
PERFORMANTE A 16 TAGLIENTI**

SLN12X

**FRESA A SPALLAMENTO
TANGENZIALE PRODUTTIVA**





DORMER PRAMET



AL TOP DELL'EFFICIENZA

T9415 | Il nostro più avanzato grado di tornitura dell'acciaio verificato dai nostri clienti.



www.dormerpramet.com/T9415

PRAMET



| | | | |
|----|------------------|------------------|---|
| 4 | TORNITURA | T9415 | QUALITA' CVD DI NUOVA GENERAZIONE |
| 38 | | T8430 | ROMPITRUCIOLI E RAGGI AGGIUNTIVI |
| 40 | | KR | ESTENSIONE QUALITA' PER TORNITURA DI GHISA |
| 42 | | S-TYPE | PORTA INSERTI PER MACCHINE A FANTINA MOBILE |
| 44 | | P & M | NUOVA LINEA DI UTENSILI PER INSERTI NEGATIVI |
| 46 | FRESATURA | SON06C | FRESA A SPIANARE PERFORMANTE A 16 TAGLIENTI |
| 56 | | SSD13F | FRESA A SPIANARE VERSATILE |
| 64 | | SLN12X | FRESA A SPALLAMENTO TANGENZIALE PRODUTTIVA |
| 72 | | SNGX 11 | GEOMETRIA ROBUSTA PER ALTO AVANZAMENTO - HM |
| 74 | | SBN10 | FRESE A MANICOTTO AGGIUNTIVE |
| 76 | | SWN04C | FRESE AD ALTA PRECISIONE RINNOVATE |
| 79 | | | INFORMAZIONI TECNICHE |



T9415

GRADO MT-CVD DI NUOVA GENERAZIONE

INTRODUZIONE



È stata introdotta una qualità di tornitura di nuova generazione che offre oggi uno dei più alti livelli di produttività e versatilità sul mercato. Il T9415 è il nostro grado MT-CVD più avanzato, che offre una maggiore stabilità e prestazioni in diverse condizioni di taglio. Copre un'ampia gamma di applicazioni, sostituendo i nostri precedenti gradi T9310 e T9315. Inoltre, si sovrappone anche parzialmente al grado T9325, rendendo il T9415 la prima scelta per la tornitura dell'acciaio.

 PRAMET

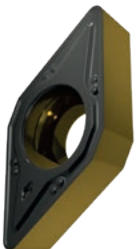

T9415

- Inserti Positivi
- Acciai, ghise, acciai duri

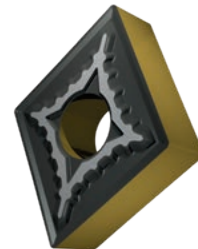

T9415

- Inserti negativi
- Acciai, ghise, acciai duri



INSERTI DI TORNITURA

CARATTERISTICHE E VANTAGGI

Gamma di applicazioni notevolmente migliorata.



QUALITA' DI PRIMA SCELTA

per la tornitura di acciai (ISO-P).

Il nuovo rivestimento MT-CVD è più spesso del 30 % e produce una maggiore resistenza all'usura sul fianco, alla craterizzazione ed alla deformazione plastica.



VITA UTENSILE E PRODUTTIVITÀ

notevolmente aumentate rispetto alle qualità precedenti.

Processo post-trattamento di nuova concezione che rafforza la stabilità del tagliente.



AFFIDABILITÀ MIGLIORATA

soprattutto in condizioni instabili.

Inserti prodotti con processo elettronico di sinterizzazione di ultima generazione.



ALTA PRECISIONE

migliora la precisione del posizionamento e riduce i tempi passivi.

Preparazione tagliente ottimizzata.



FORZE DI TAGLIO RIDOTTE

e prestazioni migliorate.

Superficie di appoggio dell'inserto rettificata dopo il rivestimento, fornisce un'area di contatto più ampia e migliora il trasferimento di calore lontano dalla zona di taglio.



MIGLIORE STABILITÀ DELLA SEDE

e una maggiore durata complessiva dell'utensile.

Piano d'appoggio inserto rettificato dopo il rivestimento.



SOSTENIBILE

offerta ecologica.

Fianchi inserto color oro rivestiti TiN.



RILEVAMENTO PIU' SEMPLICE DELL'USURA.

AREA DI APPLICAZIONE DELLE QUALITA' DI TORNITURA MT-CVD

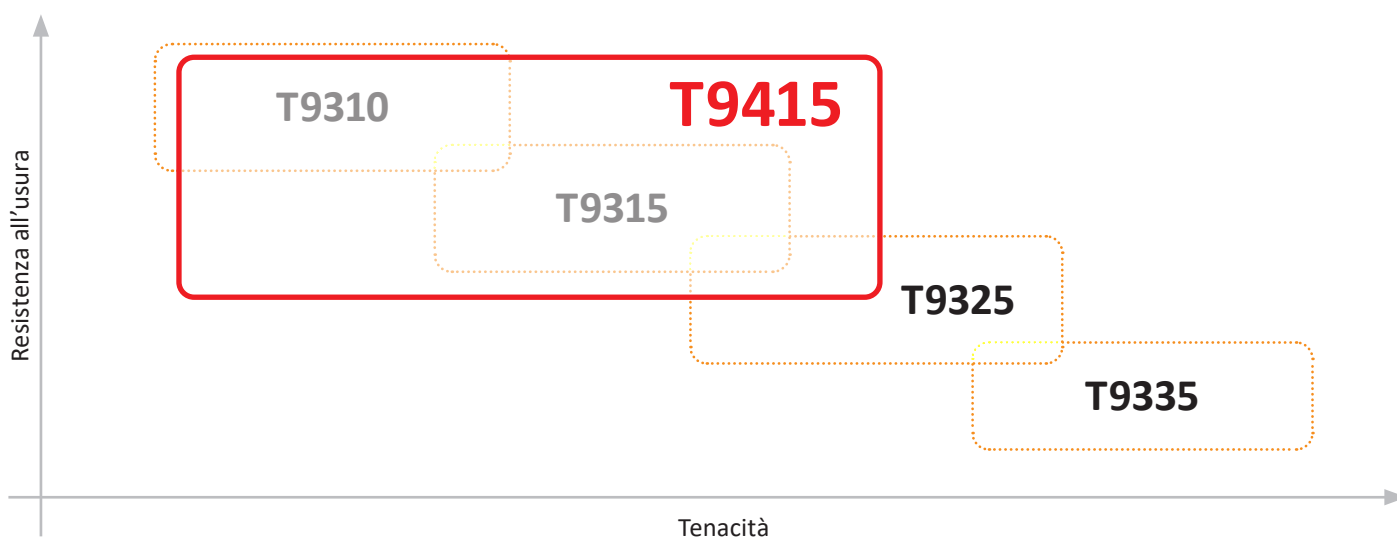



T9415

GRADO MT-CVD DI NUOVA GENERAZIONE

COMPOSIZIONE DEL GRADO

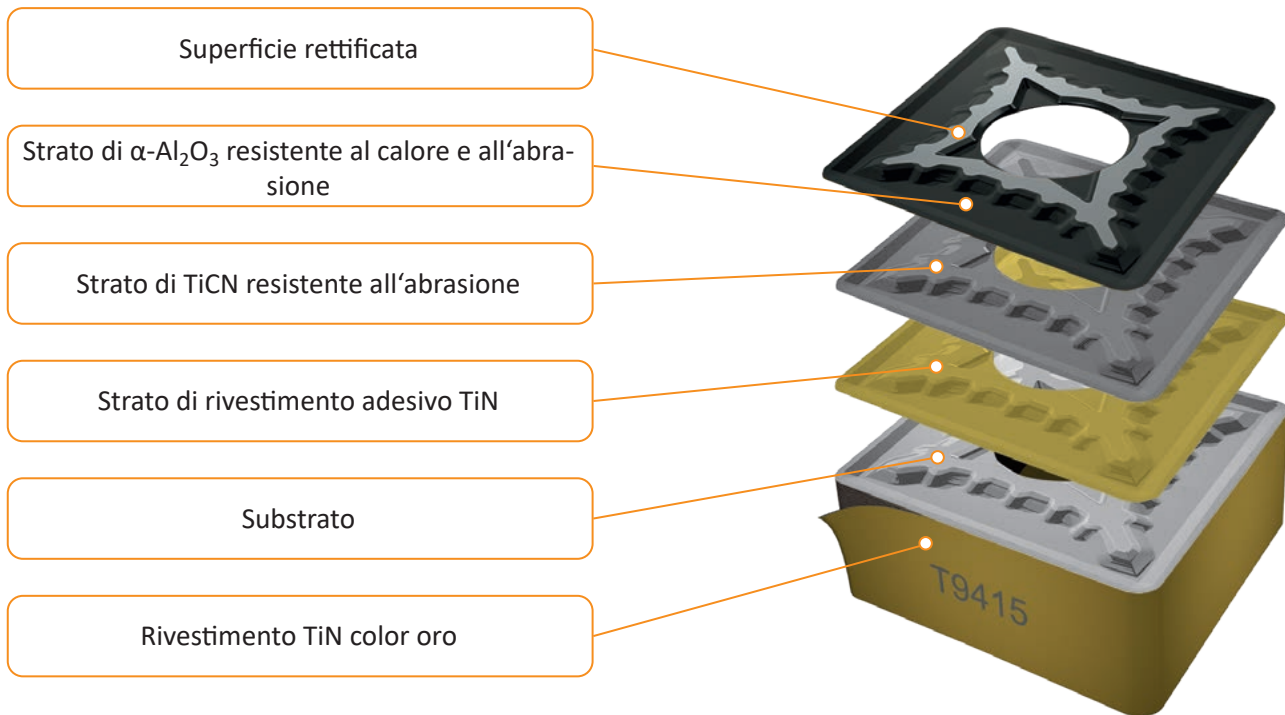

Il nuovo rivestimento CVD è più spesso del 30 % rispetto al grado precedente.

DIAGRAMMA A RAGNATELA DELLE CARATTERISTICHE

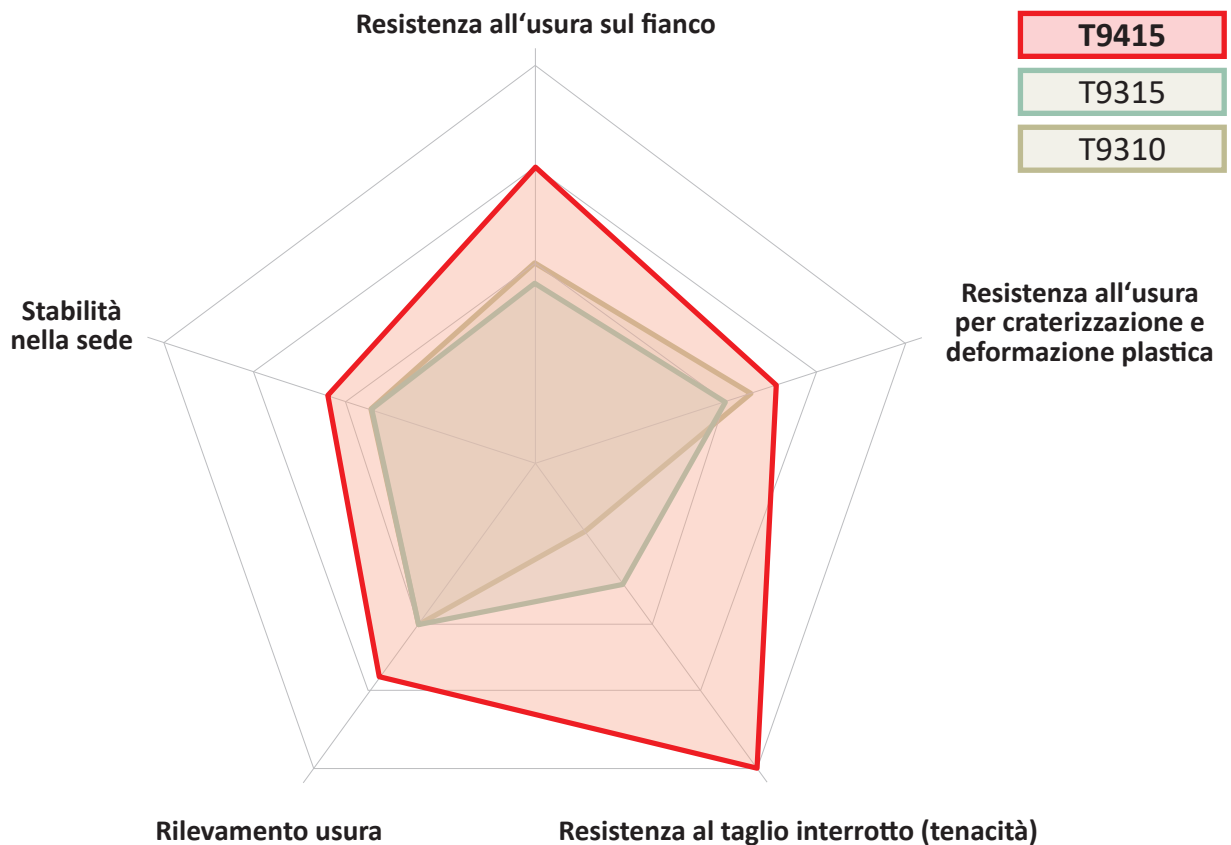



INSERTI DI TORNITURA

ESEMPI DI LAVORAZIONI

Materiale: C45 (Acciaio al carbonio di media resistenza)
 Lavorazione: Taglio continuo
 Applicazione: Tornitura longitudinale
 Refrigerante: Sì

| Condizioni di lavoro | | |
|----------------------|--------------|------------|
| v_c (m/min) | f_n (mm/r) | a_p (mm) |
| 300 | 0.25 | 2 |
| Inserto | | |
| CNMG 120408E-M | | |

Foto usure inserti dopo 16 min. di lavoro su taglio continuo.

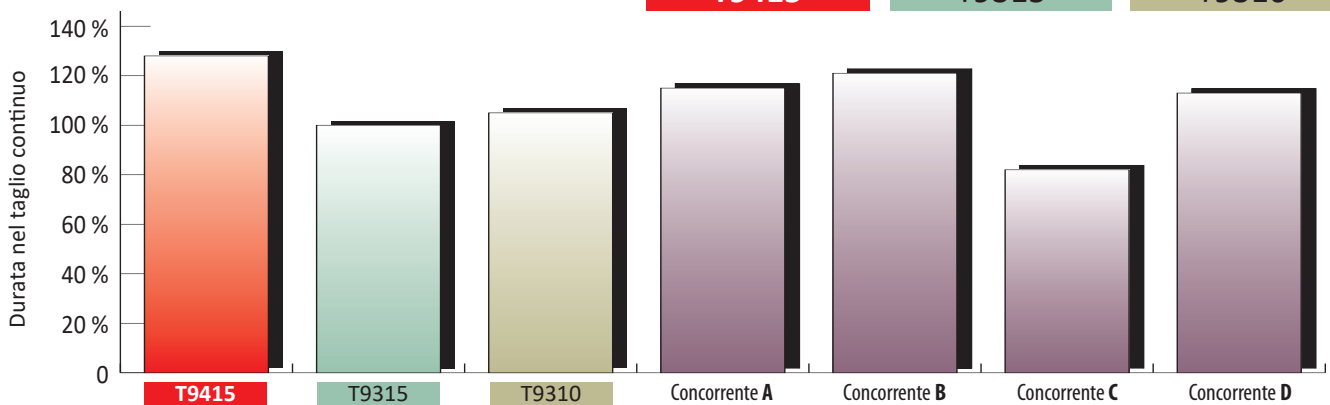

Materiale: 37Cr4 (Acciaio al cromo)
 Lavorazione: Taglio interrotto
 Applicazione: Tornitura longitudinale
 Refrigerante: No

| Condizioni di lavoro | | |
|----------------------|--------------|------------|
| v_c (m/min) | f_n (mm/r) | a_p (mm) |
| 120 | 0.2 | 1 |
| Inserto | | |
| CNMG 120408E-M | | |

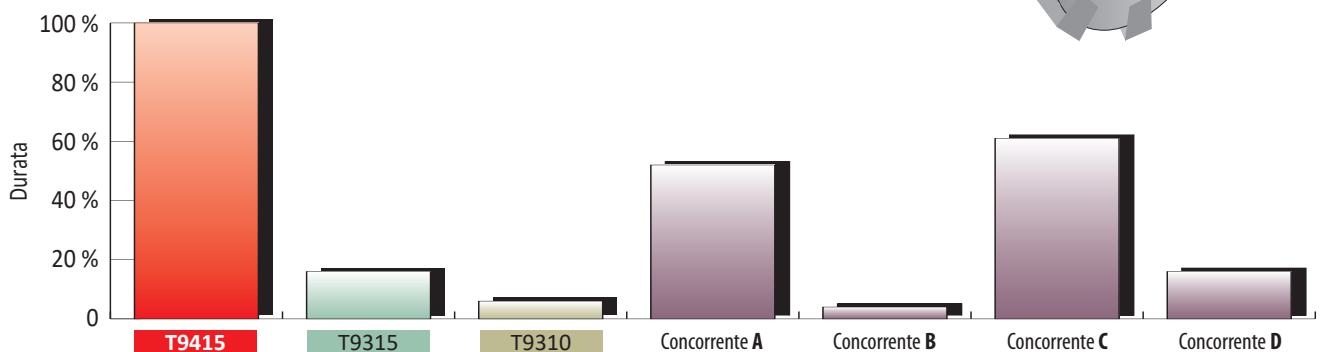
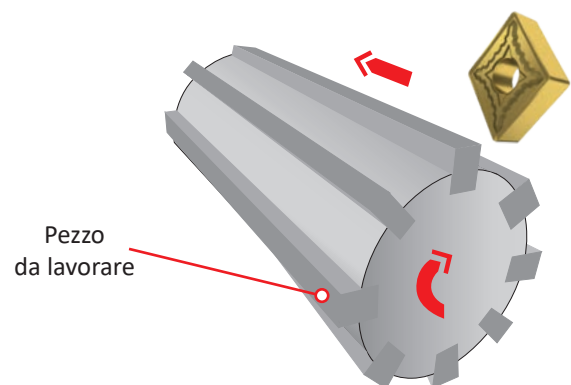

v_c = velocità di taglio, f_n = avanzamento per giro, a_p = profondità di taglio

**T9415****GRADO MT-CVD DI NUOVA GENERAZIONE****STORIE DI SUCCESSO – T9415**

Società: Subappaltatore per un'importante società brasiliana di petrolio e gas

Componente: Anello separatore

Materiale: SAE 1045 (Acciaio al carbonio)

Durezza: 250 HB

Applicazione: Tornitura interna taglio continuo. Il pezzo è bloccato direttamente nel tornio tramite sistema a bloccaggio idraulico.

Risultati precedenti: Con l'inserto del precedente concorrente venivano completati cinque pezzi.

Risultato con T9415: Un totale di 10 pezzi completati, raddoppiata la produzione.

Soluzione Dormer Pramet

CNMG 120412E-RM:T9415

Condizioni di lavoro

| v_c (m/min) | f_n (mm/r) | a_p (mm) |
|---------------|--------------|------------|
| 250 | 0.3 | 3 |

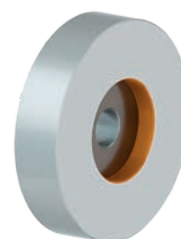

Società: Produttore italiano di dispositivi di bloccaggio dell'albero per il processo di produzione di energia.

Materiale: C45N (Acciaio al carbonio di media resistenza)

Durezza: 172 – 242 HB

Refrigerante: Sì

Applicazione: Tornitura esterna taglio continuo, contatto breve.

Risultati precedenti: Tornitura diametro esterno aumentando rispetto al concorrente la vita inserto e mantenendo lo stesso grado di finitura superficiale.

Risultato con T9415: L'utilizzo del nuovo grado ha comportato un aumento del 20 % nella vita utensile, portando un notevole risparmio al cliente.

Soluzione Dormer Pramet

CNMG 120412E-RM:T9415

Condizioni di lavoro

| v_c (m/min) | f_n (mm/r) | a_p (mm) |
|---------------|--------------|------------|
| 200 | 0.35 | 3 |



Società: Produttore di valvole industriali in Italia

Componente: Stampo

Materiale: DIN 1.2344 (Acciaio per utensili)

Durezza: Variabile secondo il trattamento termico.

Refrigerante: Sì

Applicazione: Operazione di sfacciatura su tornio verticale con materiale di durezza variabile.

Risultati precedenti: Il grado T9325 non ha resistito alla durezza variabile del pezzo. Questo ha portato alla rapida usura dell'inserto ed alla scarsa finitura superficiale del pezzo.

Risultato con T9415: Il grado ha funzionato molto bene a bassa velocità di taglio ed avanzamento. Ha fornito le migliori prestazioni nelle operazioni di sgrossatura. Con un tagliente è stato lavorato un componente di grandi dimensioni con diametro di 2500 mm.

Soluzione Dormer Pramet

SNMM 250924E-HR:T9415

Condizioni di lavoro

| v_c (m/min) | f_n (mm/r) | a_p (mm) |
|---------------|--------------|------------|
| 40 | 0.5 | 8 |

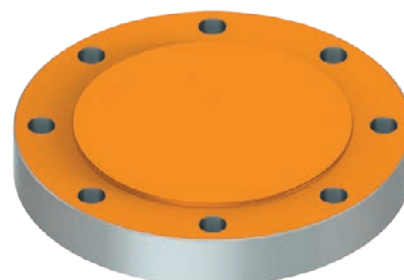



INSERTI DI TORNITURA

Società: Produttore della Repubblica Ceca di componenti di precisione per l'industria energetica, edile e automobilistica.

Particolare: Perno a doppio lato

Materiale: 15142 (42CrMo4 acciaio strutturale)

Refrigerante: Sì

Applicazione: Tornitura esterna taglio continuo su pezzo sottile

Risultati precedenti: Il cliente ha utilizzato un grado della precedente generazione riuscendo a lavorare 3 pezzi per ciascun tagliente.

Soluzione Dormer Pramet

TNMG 160408E-SM:T9415

Condizioni di lavoro

| v_c (m/min) | f_n (mm/r) | a_p (mm) |
|---------------|--------------|------------|
| 250 | 0.4 | 3 |



Risultato con T9415: Applicando il nuovo grado, il cliente ha potuto lavorare a una velocità maggiore e completare sei pezzi per ciascun tagliente. Questo non solo ha aumentato significativamente la produttività, ma ha anche raddoppiato la durata del tagliente.

Società: Azienda cinese di ingegneria automobilistica

Particolare: Blocco bilanciatura motore diesel

Materiale: Q235 (acciaio strutturale al carbonio)

Durezza: 180 – 230 HB

Refrigerante: No

Applicazione: Taglio fortemente interrotto

Risultati precedenti: Il cliente ha utilizzato un grado della concorrenza per taglio interrotto producendo quattro pezzi per tagliente. Le bave che si formavano sul pezzo indicavano il fine vita/durata del tagliente.

Soluzione Dormer Pramet

CNMG 190616E-RM:T9415

Condizioni di lavoro

| v_c (m/min) | f_n (mm/r) | a_p (mm) |
|---------------|--------------|------------|
| 150 | 0.35 | 0.6 |

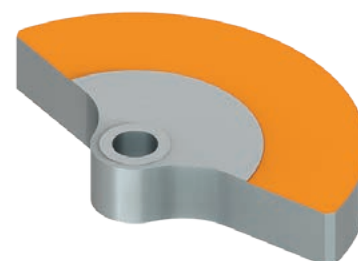

Risultato con T9415: La nuova qualità ha resistito alle condizioni di taglio esistenti, superando l'opzione precedente. Ha lavorato sei pezzi con un tagliente.









T9415

GRADO MT-CVD DI NUOVA GENERAZIONE

QUALE GRADO SCEGLIERE?

| |  |  |  |  |  |
|---|---|---|--|---|---|
| | T9415 | T9310 | T9315 | T9325 | T9335 |
| Alta velocità di taglio, elevata rigidità del sistema (condizioni di lavoro stabili) |  |  |  | - | - |
| Elevata velocità di taglio, rigidità del sistema leggermente limitato (differente profondità di taglio) |  | - |  |  | - |
| Velocità di taglio media, rigidità limitata del sistema (taglio leggermente interrotto) |  | - | - |  |  |
| Bassa velocità di taglio, bassa rigidità del sistema (taglio interrotto) | - | - | - | - |  |

INFORMAZIONI TECNICHE

| Identificazione del grado | Area di applicazione | Applicazione | Avanzamento | Velocità di taglio | Resistenza alle condizioni avverse di lavorazione | Rivestimento | Colore | Substrato | Benefici del refrigerante |
|---------------------------|----------------------|--------------|---|---|--|--------------|---|-----------|---------------------------|
| T9415 | P05 – P30 | ■ |  |  |  | MT-CVD |  | FGM | ++ |
| | K05 – K25 | ▣ | | | | | | | |
| | H10 – H20 | ▣ | | | | | | | |

Descrizione del grado:

Qualità altamente resistente all'usura progettata principalmente per la tornitura di finitura dei comuni acciai al carbonio e legati. Nonostante la sua elevata resistenza all'abrasione, è adatto anche per operazioni con taglio interrotto. Consigliamo questa qualità come prima scelta per la maggior parte delle operazioni di tornitura, soprattutto in applicazioni ad alta produzione.



INSERTI ISO POSITIVI – NAVIGATORE ROMPITRUCIOLO

 Condizioni molto instabili

 Condizioni instabili

 Condizioni stabili

 Pezzo in lavorazione con pareti sottili

 Prima scelta per condizioni di lavoro stabili
 Varianti per diverse condizioni di lavoro

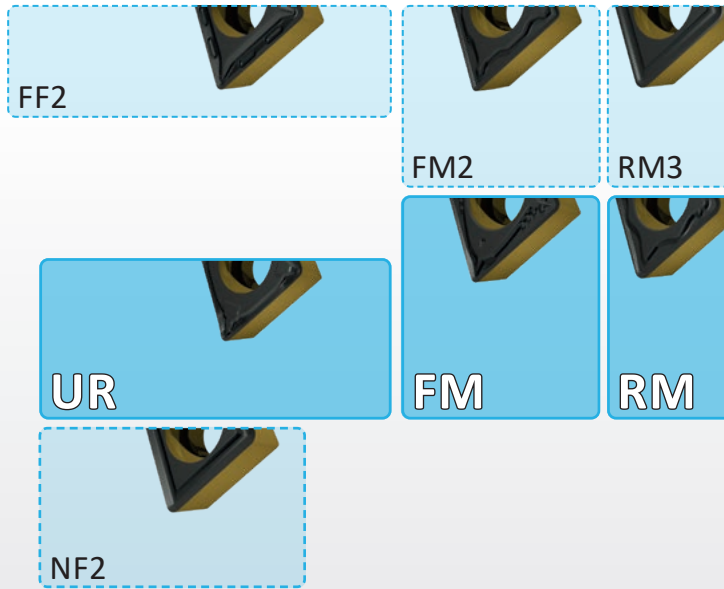



INSERTI ISO NEGATIVI – NAVIGATORE ROMPITRUCIOLO

 Condizioni molto instabili





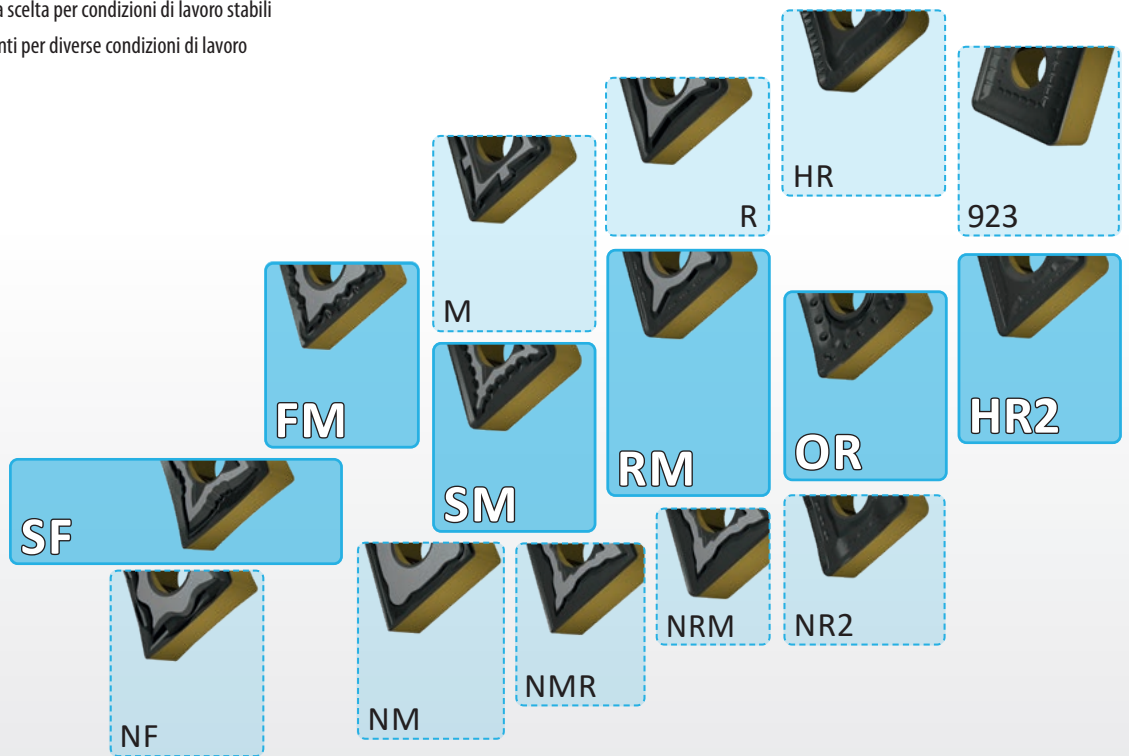

 Condizioni instabili

 Condizioni stabili

 Pezzo in lavorazione con pareti sottili

 Prima scelta per condizioni di lavoro stabili
 Varianti per diverse condizioni di lavoro



| |  |  |  |  |  |
|---|---|---|---|---|---|
|  | 0.05 – 0.2 mm/r | | 0.2 – 0.4 mm/r | 0.4 – 1.0 mm/r | > 1.0 mm/r |
|  | 0.05 – 2 mm | | 2 – 4 mm | 4 – 10 mm | > 10 mm |



CCMT



| | IC | D1 | L | S |
|------|--------|------|-------|------|
| | (mm) | (mm) | (mm) | (mm) |
| 0602 | 6.350 | 2.80 | 6.40 | 2.38 |
| 0803 | 7.940 | 3.40 | 8.10 | 3.18 |
| 09T3 | 9.525 | 4.40 | 9.70 | 3.97 |
| 1204 | 12.700 | 5.50 | 12.90 | 4.76 |

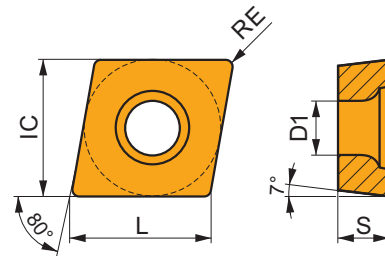

Idoneità e valori iniziali per velocità di taglio (Vc), avanzamento (f) e profondità di taglio (ap). Fare riferimento alla nostra App Machining Calculator per ulteriori calcoli.

| Prodotto | RE | P | | | M | | | K | | | N | | | S | | | H | | |
|----------|------|---------|----------|------|---------|----------|------|---------|----------|------|---------|----------|------|---------|----------|------|---------|----------|------|
| | | vc | f | ap | vc | f | ap | vc | f | ap | vc | f | ap | vc | f | ap | vc | f | ap |
| | (mm) | (m/min) | (mm/rev) | (mm) | (m/min) | (mm/rev) | (mm) | (m/min) | (mm/rev) | (mm) | (m/min) | (mm/rev) | (mm) | (m/min) | (mm/rev) | (mm) | (m/min) | (mm/rev) | (mm) |

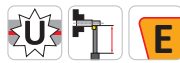
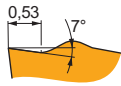
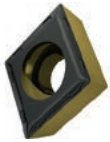

FF2 geometria positiva per operazioni da super finitura fino a finitura, da taglio continuo a leggermente interrotto.

| | | | | | | | | | | | | | | | | | | | |
|------------------|-------|-----|-----|------|-----|---|---|---|-----|------|-----|---|---|---|---|---|---|---|---|
| CCMT 060202E-FF2 | T9415 | 0.2 | 395 | 0.05 | 0.8 | — | — | — | 375 | 0.05 | 0.8 | — | — | — | — | — | — | — | — |
| CCMT 060204E-FF2 | T9415 | 0.4 | 305 | 0.12 | 1.0 | — | — | — | 285 | 0.12 | 1.0 | — | — | — | — | — | — | — | — |
| CCMT 09T304E-FF2 | T9415 | 0.4 | 300 | 0.12 | 1.2 | — | — | — | 285 | 0.12 | 1.2 | — | — | — | — | — | — | — | — |
| CCMT 09T308E-FF2 | T9415 | 0.8 | 300 | 0.20 | 1.2 | — | — | — | 285 | 0.20 | 1.2 | — | — | — | — | — | — | — | — |

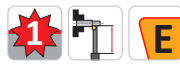
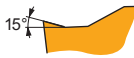
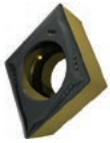

FM geometria per operazioni da finitura fino a semi sgrossatura, da taglio continuo a leggermente interrotto.

| | | | | | | | | | | | | | | | | | | | |
|-----------------|-------|-----|-----|------|-----|---|---|---|-----|------|-----|---|---|---|---|---|---|---|---|
| CCMT 060202E-FM | T9415 | 0.2 | 335 | 0.10 | 1.0 | — | — | — | 315 | 0.10 | 1.0 | — | — | — | — | — | — | — | — |
| CCMT 060204E-FM | T9415 | 0.4 | 310 | 0.15 | 1.0 | — | — | — | 290 | 0.15 | 1.0 | — | — | — | — | — | — | — | — |
| CCMT 060208E-FM | T9415 | 0.8 | 335 | 0.20 | 1.0 | — | — | — | 315 | 0.20 | 1.0 | — | — | — | — | — | — | — | — |
| CCMT 09T302E-FM | T9415 | 0.2 | 330 | 0.10 | 1.2 | — | — | — | 310 | 0.10 | 1.2 | — | — | — | — | — | — | — | — |
| CCMT 09T304E-FM | T9415 | 0.4 | 305 | 0.15 | 1.2 | — | — | — | 285 | 0.15 | 1.2 | — | — | — | — | — | — | — | — |
| CCMT 09T308E-FM | T9415 | 0.8 | 330 | 0.20 | 1.2 | — | — | — | 310 | 0.20 | 1.2 | — | — | — | — | — | — | — | — |
| CCMT 120404E-FM | T9415 | 0.4 | 295 | 0.15 | 1.7 | — | — | — | 280 | 0.15 | 1.7 | — | — | — | — | — | — | — | — |
| CCMT 120408E-FM | T9415 | 0.8 | 315 | 0.20 | 1.7 | — | — | — | 295 | 0.20 | 1.7 | — | — | — | — | — | — | — | — |

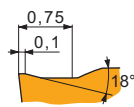
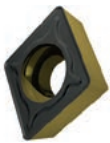

FM2 geometria per operazioni da finitura fino a lavorazioni medie, da taglio continuo a interrotto.

| | | | | | | | | | | | | | | | | | | | |
|------------------|-------|-----|-----|------|-----|---|---|---|-----|------|-----|---|---|---|---|---|---|---|---|
| CCMT 080304E-FM2 | T9415 | 0.4 | 305 | 0.12 | 1.0 | — | — | — | 285 | 0.12 | 1.0 | — | — | — | — | — | — | — | — |
| CCMT 09T304E-FM2 | T9415 | 0.4 | 305 | 0.12 | 1.0 | — | — | — | 285 | 0.12 | 1.0 | — | — | — | — | — | — | — | — |
| CCMT 09T308E-FM2 | T9415 | 0.8 | 320 | 0.17 | 1.0 | — | — | — | 300 | 0.17 | 1.0 | — | — | — | — | — | — | — | — |

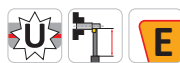
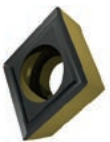

NF2 geometria con design positivo per operazioni da finitura ea semi sgrossatura, taglio continuo.

| | | | | | | | | | | | | | | | | | | | |
|------------------|-------|-----|-----|------|-----|---|---|---|-----|------|-----|---|---|---|---|---|---|---|---|
| CCMT 060204E-NF2 | T9415 | 0.4 | 315 | 0.12 | 0.8 | — | — | — | 295 | 0.12 | 0.8 | — | — | — | — | — | — | — | — |
| CCMT 080304E-NF2 | T9415 | 0.4 | 305 | 0.12 | 1.0 | — | — | — | 285 | 0.12 | 1.0 | — | — | — | — | — | — | — | — |
| CCMT 09T304E-NF2 | T9415 | 0.4 | 300 | 0.12 | 1.2 | — | — | — | 285 | 0.12 | 1.2 | — | — | — | — | — | — | — | — |
| CCMT 09T308E-NF2 | T9415 | 0.8 | 340 | 0.14 | 1.2 | — | — | — | 320 | 0.14 | 1.2 | — | — | — | — | — | — | — | — |

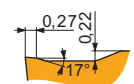
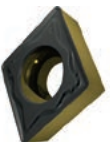

RM geometria per operazioni da semi sgrossatura fino a sgrossatura, da taglio continuo a interrotto.

| | | | | | | | | | | | | | | | | | | | |
|-----------------|-------|-----|-----|------|-----|---|---|---|-----|------|-----|---|---|---|---|---|----|------|-----|
| CCMT 09T304E-RM | T9415 | 0.4 | 255 | 0.25 | 2.2 | — | — | — | 240 | 0.25 | 2.2 | — | — | — | — | — | 50 | 0.18 | 0.3 |
| CCMT 09T308E-RM | T9415 | 0.8 | 285 | 0.30 | 2.2 | — | — | — | 270 | 0.30 | 2.2 | — | — | — | — | — | 55 | 0.15 | 0.7 |



Idoneità e valori iniziali per velocità di taglio (Vc), avanzamento (f) e profondità di taglio (ap). Fare riferimento alla nostra App Machining Calculator per ulteriori calcoli.

| Prodotto | RE (mm) | P | | | M | | | K | | | N | | | S | | | H | | |
|----------|------------|---------------|---------------|------------|---------------|---------------|------------|---------------|---------------|------------|---------------|---------------|------------|---------------|---------------|------------|---------------|---------------|------------|
| | | vc (m/min) | f (mm/rev) | ap (mm) | vc (m/min) | f (mm/rev) | ap (mm) | vc (m/min) | f (mm/rev) | ap (mm) | vc (m/min) | f (mm/rev) | ap (mm) | vc (m/min) | f (mm/rev) | ap (mm) | vc (m/min) | f (mm/rev) | ap (mm) |

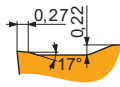
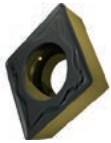

RM geometria per operazioni da semi sgrassatura fino a sgrassatura, da taglio continuo a interrotto.

| | | | | | | | | | | | | | | | | | | | | |
|-----------------|-------|-----|-----|------|-----|---|---|---|-----|------|-----|---|---|---|---|---|---|----|------|-----|
| CCMT 120408E-RM | T9415 | 0.8 | 280 | 0.30 | 2.7 | — | — | — | 265 | 0.30 | 2.7 | — | — | — | — | — | — | 55 | 0.15 | 0.7 |
| CCMT 120412E-RM | T9415 | 1.2 | 280 | 0.33 | 2.7 | — | — | — | 265 | 0.33 | 2.7 | — | — | — | — | — | — | 55 | 0.17 | 1.0 |

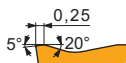
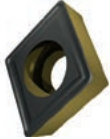

RM3 geometria per operazioni da semi sgrassatura fino a sgrassatura, da taglio continuo a interrotto.

| | | | | | | | | | | | | | | | | | | | | |
|------------------|-------|-----|-----|------|-----|---|---|---|-----|------|-----|---|---|---|---|---|---|----|------|-----|
| CCMT 120404E-RM3 | T9415 | 0.4 | 215 | 0.25 | 2.5 | — | — | — | 200 | 0.25 | 2.5 | — | — | — | — | — | — | 40 | 0.13 | 0.3 |
| CCMT 120408E-RM3 | T9415 | 0.8 | 250 | 0.27 | 2.5 | — | — | — | 235 | 0.27 | 2.5 | — | — | — | — | — | — | 50 | 0.14 | 0.7 |
| CCMT 120412E-RM3 | T9415 | 1.2 | 255 | 0.30 | 2.5 | — | — | — | 240 | 0.30 | 2.5 | — | — | — | — | — | — | 50 | 0.15 | 1.0 |

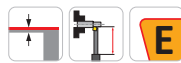
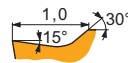
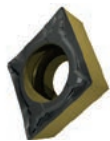

UR geometria per lavorazioni leggere e finitura, da taglio continuo a leggermente interrotto.

| | | | | | | | | | | | | | | | | | | | | |
|-----------------|-------|-----|-----|------|-----|---|---|---|-----|------|-----|---|---|---|---|---|---|---|---|---|
| CCMT 060202E-UR | T9415 | 0.2 | 295 | 0.10 | 0.8 | — | — | — | 280 | 0.10 | 0.8 | — | — | — | — | — | — | — | — | — |
| CCMT 060204E-UR | T9415 | 0.4 | 270 | 0.15 | 1.0 | — | — | — | 255 | 0.15 | 1.0 | — | — | — | — | — | — | — | — | — |
| CCMT 060208E-UR | T9415 | 0.8 | 290 | 0.20 | 1.0 | — | — | — | 275 | 0.20 | 1.0 | — | — | — | — | — | — | — | — | — |
| CCMT 09T304E-UR | T9415 | 0.4 | 265 | 0.15 | 1.2 | — | — | — | 250 | 0.15 | 1.2 | — | — | — | — | — | — | — | — | — |
| CCMT 09T308E-UR | T9415 | 0.8 | 285 | 0.20 | 1.2 | — | — | — | 270 | 0.20 | 1.2 | — | — | — | — | — | — | — | — | — |
| CCMT 120404E-UR | T9415 | 0.4 | 255 | 0.15 | 1.7 | — | — | — | 240 | 0.15 | 1.7 | — | — | — | — | — | — | — | — | — |
| CCMT 120408E-UR | T9415 | 0.8 | 275 | 0.20 | 1.7 | — | — | — | 260 | 0.20 | 1.7 | — | — | — | — | — | — | — | — | — |
| CCMT 120412E-UR | T9415 | 1.2 | 265 | 0.27 | 1.7 | — | — | — | 250 | 0.27 | 1.7 | — | — | — | — | — | — | — | — | — |

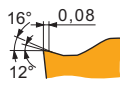
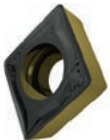

W-FM geometria wiper per lavorazioni leggere e finitura con maggiore velocità di avanzamento e finitura superficiale ottimizzata.

| | | | | | | | | | | | | | | | | | | | | |
|-----------------|-------|-----|-----|------|-----|---|---|---|-----|------|-----|---|---|---|---|---|---|---|---|---|
| CCMT 060204W-FM | T9415 | 0.4 | 250 | 0.30 | 0.8 | — | — | — | 235 | 0.30 | 0.8 | — | — | — | — | — | — | — | — | — |
| CCMT 09T304W-FM | T9415 | 0.4 | 305 | 0.15 | 1.2 | — | — | — | 285 | 0.15 | 1.2 | — | — | — | — | — | — | — | — | — |

CNMG



| | IC (mm) | D1 (mm) | L (mm) | S (mm) |
|------|------------|------------|-----------|-----------|
| 0903 | 9.525 | 3.81 | 9.70 | 3.18 |
| 1204 | 12.700 | 5.16 | 12.90 | 4.76 |
| 1606 | 15.875 | 6.35 | 16.10 | 6.35 |
| 1906 | 19.050 | 7.94 | 19.30 | 6.35 |
| 2509 | 25.400 | 9.12 | 25.80 | 9.53 |

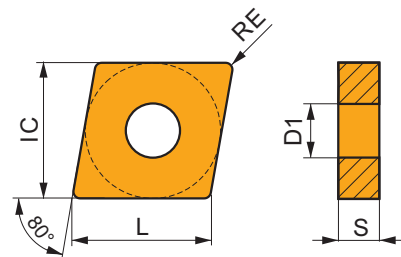

Idoneità e valori iniziali per velocità di taglio (Vc), avanzamento (f) e profondità di taglio (ap). Fare riferimento alla nostra App Machining Calculator per ulteriori calcoli.

| Prodotto | RE (mm) | P | | | M | | | K | | | N | | | S | | | H | | |
|----------|------------|---------------|---------------|------------|---------------|---------------|------------|---------------|---------------|------------|---------------|---------------|------------|---------------|---------------|------------|---------------|---------------|------------|
| | | vc (m/min) | f (mm/rev) | ap (mm) | vc (m/min) | f (mm/rev) | ap (mm) | vc (m/min) | f (mm/rev) | ap (mm) | vc (m/min) | f (mm/rev) | ap (mm) | vc (m/min) | f (mm/rev) | ap (mm) | vc (m/min) | f (mm/rev) | ap (mm) |

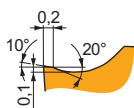
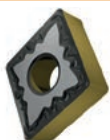

FM geometria positiva per operazioni da finitura fino a semi sgrassatura, da taglio continuo a leggermente interrotto.

| | | | | | | | | | | | | | | | | | | | | |
|-----------------|-------|-----|-----|------|-----|---|---|---|-----|------|-----|---|---|---|---|---|---|---|---|---|
| CNMG 090304E-FM | T9415 | 0.4 | 305 | 0.20 | 1.4 | — | — | — | 285 | 0.20 | 1.4 | — | — | — | — | — | — | — | — | — |
|-----------------|-------|-----|-----|------|-----|---|---|---|-----|------|-----|---|---|---|---|---|---|---|---|---|



Idoneità e valori iniziali per velocità di taglio (Vc), avanzamento (f) e profondità di taglio (ap). Fare riferimento alla nostra App Machining Calculator per ulteriori calcoli.

| Prodotto | RE (mm) | P | | | M | | | K | | | N | | | S | | | H | | |
|----------|------------|---------------|---------------|------------|---------------|---------------|------------|---------------|---------------|------------|---------------|---------------|------------|---------------|---------------|------------|---------------|---------------|------------|
| | | vc (m/min) | f (mm/rev) | ap (mm) | vc (m/min) | f (mm/rev) | ap (mm) | vc (m/min) | f (mm/rev) | ap (mm) | vc (m/min) | f (mm/rev) | ap (mm) | vc (m/min) | f (mm/rev) | ap (mm) | vc (m/min) | f (mm/rev) | ap (mm) |

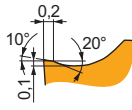
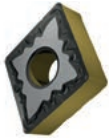

FM geometria positiva per operazioni da finitura fino a semi sgrossatura, da taglio continuo a leggermente interrotto.

| | | | | | | | | | | | | | | | | | | | |
|-----------------|-------|-----|-----|------|-----|---|---|---|-----|------|-----|---|---|---|---|---|---|---|---|
| CNMG 090308E-FM | T9415 | 0.8 | 365 | 0.20 | 1.4 | - | - | - | 345 | 0.20 | 1.4 | - | - | - | - | - | - | - | - |
| CNMG 120404E-FM | T9415 | 0.4 | 290 | 0.20 | 2.1 | - | - | - | 275 | 0.20 | 2.1 | - | - | - | - | - | - | - | - |
| CNMG 120408E-FM | T9415 | 0.8 | 350 | 0.20 | 2.1 | - | - | - | 330 | 0.20 | 2.1 | - | - | - | - | - | - | - | - |
| CNMG 120412E-FM | T9415 | 1.2 | 330 | 0.27 | 2.1 | - | - | - | 310 | 0.27 | 2.1 | - | - | - | - | - | - | - | - |

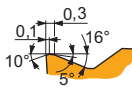
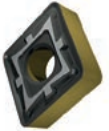

M geometria per operazioni da finitura fino a semi sgrossatura, da taglio continuo a interrotto.

| | | | | | | | | | | | | | | | | | | | |
|----------------|-------|-----|-----|------|-----|---|---|---|-----|------|-----|---|---|---|---|---|----|------|-----|
| CNMG 090308E-M | T9415 | 0.8 | 275 | 0.32 | 1.8 | - | - | - | 260 | 0.32 | 1.8 | - | - | - | - | - | 55 | 0.16 | 0.5 |
| CNMG 120404E-M | T9415 | 0.4 | 265 | 0.20 | 2.1 | - | - | - | 250 | 0.20 | 2.1 | - | - | - | - | - | 50 | 0.13 | 0.3 |
| CNMG 120408E-M | T9415 | 0.8 | 270 | 0.32 | 2.1 | - | - | - | 255 | 0.32 | 2.1 | - | - | - | - | - | 50 | 0.16 | 0.7 |
| CNMG 120412E-M | T9415 | 1.2 | 265 | 0.40 | 2.1 | - | - | - | 250 | 0.40 | 2.1 | - | - | - | - | - | 50 | 0.20 | 1.0 |
| CNMG 160608E-M | T9415 | 0.8 | 255 | 0.32 | 3.6 | - | - | - | 240 | 0.32 | 3.6 | - | - | - | - | - | 50 | 0.16 | 0.7 |
| CNMG 160612E-M | T9415 | 1.2 | 250 | 0.40 | 3.6 | - | - | - | 235 | 0.40 | 3.6 | - | - | - | - | - | 50 | 0.20 | 1.0 |
| CNMG 190608E-M | T9415 | 0.8 | 250 | 0.32 | 4.2 | - | - | - | 235 | 0.32 | 4.2 | - | - | - | - | - | 50 | 0.16 | 0.7 |
| CNMG 190612E-M | T9415 | 1.2 | 245 | 0.40 | 4.2 | - | - | - | 230 | 0.40 | 4.2 | - | - | - | - | - | 45 | 0.20 | 1.0 |
| CNMG 190616E-M | T9415 | 1.6 | 255 | 0.40 | 4.2 | - | - | - | 240 | 0.40 | 4.2 | - | - | - | - | - | 50 | 0.20 | 1.3 |

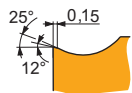
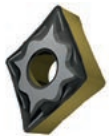

NF geometria con design altamente positivo per operazioni da finitura fino a medie lavorazioni, taglio continuo.

| | | | | | | | | | | | | | | | | | | | |
|-----------------|-------|-----|-----|------|-----|---|---|---|-----|------|-----|---|---|---|---|---|---|---|---|
| CNMG 120404E-NF | T9415 | 0.4 | 315 | 0.17 | 1.7 | - | - | - | 295 | 0.17 | 1.7 | - | - | - | - | - | - | - | - |
| CNMG 120408E-NF | T9415 | 0.8 | 360 | 0.19 | 1.7 | - | - | - | 340 | 0.19 | 1.7 | - | - | - | - | - | - | - | - |
| CNMG 120412E-NF | T9415 | 1.2 | 315 | 0.30 | 2.1 | - | - | - | 295 | 0.30 | 2.1 | - | - | - | - | - | - | - | - |

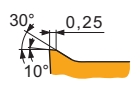
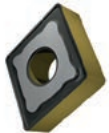

NM geometria con design altamente positivo per operazioni di finitura, media sgrossatura, taglio continuo.

| | | | | | | | | | | | | | | | | | | | |
|-----------------|-------|-----|-----|------|-----|---|---|---|---|---|---|---|---|---|---|---|---|---|---|
| CNMG 120404E-NM | T9415 | 0.4 | 305 | 0.20 | 2.1 | - | - | - | - | - | - | - | - | - | - | - | - | - | - |
| CNMG 120408E-NM | T9415 | 0.8 | 335 | 0.25 | 2.1 | - | - | - | - | - | - | - | - | - | - | - | - | - | - |

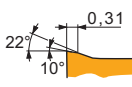

NMR geometria con design positivo per operazioni da media fino a sgrossatura, taglio continuo.

| | | | | | | | | | | | | | | | | | | | |
|------------------|-------|-----|-----|------|-----|----|------|-----|---|---|---|----|------|-----|---|---|---|---|---|
| CNMG 120404E-NMR | T9415 | 0.4 | 245 | 0.25 | 2.0 | - | - | - | - | - | - | - | - | - | - | - | - | - | - |
| CNMG 120408E-NMR | T9415 | 0.8 | 255 | 0.35 | 2.7 | - | - | - | - | - | - | - | - | - | - | - | - | - | - |
| CNMG 120412E-NMR | T9415 | 1.2 | 255 | 0.40 | 2.7 | - | - | - | - | - | - | - | - | - | - | - | - | - | - |
| CNMG 120416E-NMR | T8430 | 1.6 | 155 | 0.45 | 2.7 | 85 | 0.41 | 2.7 | - | - | - | 30 | 0.32 | 2.2 | - | - | - | - | - |
| CNMG 160608E-NMR | T9415 | 0.8 | 245 | 0.35 | 4.0 | - | - | - | - | - | - | - | - | - | - | - | - | - | - |
| CNMG 160612E-NMR | T9415 | 1.2 | 245 | 0.40 | 4.0 | - | - | - | - | - | - | - | - | - | - | - | - | - | - |
| CNMG 160616E-NMR | T9415 | 1.6 | 240 | 0.45 | 6.0 | - | - | - | - | - | - | - | - | - | - | - | - | - | - |
| CNMG 190608E-NMR | T9415 | 0.8 | 225 | 0.35 | 8.0 | - | - | - | - | - | - | - | - | - | - | - | - | - | - |
| CNMG 190616E-NMR | T8430 | 1.6 | 145 | 0.45 | 5.2 | 80 | 0.41 | 5.2 | - | - | - | 30 | 0.32 | 4.2 | - | - | - | - | - |
| | T9415 | 1.6 | 240 | 0.45 | 5.2 | - | - | - | - | - | - | - | - | - | - | - | - | - | - |

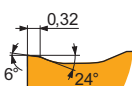

NRM geometria con design positivo per operazioni da semi sgrossatura fino a sgrossatura, da taglio continuo a moderatamente interrotto.

| | | | | | | | | | | | | | | | | | | | |
|-----------------|-------|-----|-----|------|-----|----|------|-----|---|---|---|----|------|-----|---|---|---|---|---|
| CNMG 120408-NRM | T8430 | 0.8 | 150 | 0.35 | 4.0 | 80 | 0.32 | 4.0 | - | - | - | 30 | 0.25 | 3.2 | - | - | - | - | - |
| | T9415 | 0.8 | 245 | 0.35 | 4.0 | - | - | - | - | - | - | - | - | - | - | - | - | - | - |
| CNMG 120412-NRM | T8430 | 1.2 | 150 | 0.40 | 4.0 | 80 | 0.36 | 4.0 | - | - | - | 30 | 0.28 | 3.2 | - | - | - | - | - |
| | T9415 | 1.2 | 245 | 0.40 | 4.0 | - | - | - | - | - | - | - | - | - | - | - | - | - | - |



Idoneità e valori iniziali per velocità di taglio (Vc), avanzamento (f) e profondità di taglio (ap). Fare riferimento alla nostra App Machining Calculator per ulteriori calcoli.

| Prodotto | RE (mm) | P | | | M | | | K | | | N | | | S | | | H | | |
|----------|------------|---------------|---------------|------------|---------------|---------------|------------|---------------|---------------|------------|---------------|---------------|------------|---------------|---------------|------------|---------------|---------------|------------|
| | | vc (m/min) | f (mm/rev) | ap (mm) | vc (m/min) | f (mm/rev) | ap (mm) | vc (m/min) | f (mm/rev) | ap (mm) | vc (m/min) | f (mm/rev) | ap (mm) | vc (m/min) | f (mm/rev) | ap (mm) | vc (m/min) | f (mm/rev) | ap (mm) |

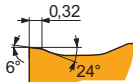

NRM geometria con design positivo per operazioni da semi sgrossatura fino a sgrossatura, da taglio continuo a moderatamente interrotto.

| | | | | | | | | | | | | | | | | | | |
|-----------------|-------|-----|-----|------|-----|----|------|-----|---|---|---|----|------|-----|---|---|---|---|
| CNMG 160608-NRM | T9415 | 0.8 | 235 | 0.35 | 6.0 | - | - | - | - | - | - | - | - | - | - | - | - | - |
| CNMG 160612-NRM | T9415 | 1.2 | 235 | 0.40 | 6.0 | - | - | - | - | - | - | - | - | - | - | - | - | - |
| CNMG 160616-NRM | T8430 | 1.6 | 145 | 0.45 | 6.0 | 80 | 0.41 | 6.0 | - | - | - | 30 | 0.32 | 4.8 | - | - | - | - |
| | T9415 | 1.6 | 240 | 0.45 | 6.0 | - | - | - | - | - | - | - | - | - | - | - | - | - |
| CNMG 190612-NRM | T8430 | 1.2 | 140 | 0.40 | 8.0 | 75 | 0.36 | 8.0 | - | - | - | 30 | 0.28 | 6.4 | - | - | - | - |
| | T9415 | 1.2 | 230 | 0.40 | 8.0 | - | - | - | - | - | - | - | - | - | - | - | - | - |
| CNMG 190616-NRM | T8430 | 1.6 | 140 | 0.45 | 8.0 | 75 | 0.41 | 8.0 | - | - | - | 30 | 0.32 | 6.4 | - | - | - | - |
| | T9415 | 1.6 | 230 | 0.45 | 8.0 | - | - | - | - | - | - | - | - | - | - | - | - | - |

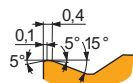
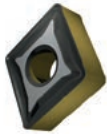

R geometria per operazioni da semi sgrossatura fino a sgrossatura, da taglio continuo a interrotto.

| | | | | | | | | | | | | | | | | | |
|----------------|-------|-----|-----|------|-----|---|---|---|-----|------|-----|---|---|---|----|------|-----|
| CNMG 120408E-R | T9415 | 0.8 | 230 | 0.40 | 4.0 | - | - | - | 215 | 0.40 | 4.0 | - | - | - | 45 | 0.20 | 0.7 |
| CNMG 120412E-R | T9415 | 1.2 | 235 | 0.45 | 4.0 | - | - | - | 220 | 0.45 | 4.0 | - | - | - | 45 | 0.23 | 1.0 |
| CNMG 160612E-R | T9415 | 1.2 | 230 | 0.45 | 5.5 | - | - | - | 215 | 0.45 | 5.5 | - | - | - | 45 | 0.23 | 1.0 |
| CNMG 190612E-R | T9415 | 1.2 | 225 | 0.45 | 7.0 | - | - | - | 210 | 0.45 | 7.0 | - | - | - | 45 | 0.23 | 1.0 |
| CNMG 190616E-R | T9415 | 1.6 | 225 | 0.50 | 7.0 | - | - | - | 210 | 0.50 | 7.0 | - | - | - | 45 | 0.25 | 1.3 |

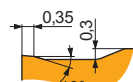
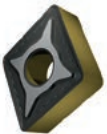

RM geometria per operazioni da semi sgrossatura fino a sgrossatura, da taglio continuo a interrotto.

| | | | | | | | | | | | | | | | | | |
|-----------------|-------|-----|-----|------|------|----|------|-----|-----|------|------|----|------|-----|---|---|---|
| CNMG 120408E-RM | T9415 | 0.8 | 265 | 0.40 | 4.0 | - | - | - | 250 | 0.40 | 4.0 | - | - | - | - | - | - |
| CNMG 120412E-RM | T9415 | 1.2 | 270 | 0.45 | 4.0 | - | - | - | 255 | 0.45 | 4.0 | - | - | - | - | - | - |
| CNMG 120416E-RM | T9415 | 1.6 | 275 | 0.50 | 4.0 | - | - | - | 260 | 0.50 | 4.0 | - | - | - | - | - | - |
| CNMG 160608E-RM | T9415 | 0.8 | 255 | 0.40 | 6.0 | - | - | - | 240 | 0.40 | 6.0 | - | - | - | - | - | - |
| CNMG 160612E-RM | T9415 | 1.2 | 260 | 0.45 | 6.0 | - | - | - | 245 | 0.45 | 6.0 | - | - | - | - | - | - |
| CNMG 160616E-RM | T9415 | 1.6 | 265 | 0.50 | 6.0 | - | - | - | 250 | 0.50 | 6.0 | - | - | - | - | - | - |
| CNMG 190608E-RM | T9415 | 0.8 | 250 | 0.40 | 7.5 | - | - | - | 235 | 0.40 | 7.5 | - | - | - | - | - | - |
| CNMG 190612E-RM | T9415 | 1.2 | 250 | 0.45 | 7.5 | - | - | - | 235 | 0.45 | 7.5 | - | - | - | - | - | - |
| CNMG 190616E-RM | T8430 | 1.6 | 150 | 0.50 | 7.5 | 80 | 0.45 | 7.5 | 125 | 0.50 | 7.5 | 30 | 0.35 | 6.0 | - | - | - |
| | T9415 | 1.6 | 255 | 0.50 | 7.5 | - | - | - | 240 | 0.50 | 7.5 | - | - | - | - | - | - |
| CNMG 250924E-RM | T9415 | 2.4 | 125 | 0.80 | 12.0 | - | - | - | 115 | 0.80 | 12.0 | - | - | - | - | - | - |

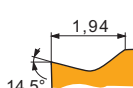
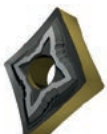

SF geometria con design positivo per operazioni di finitura su pareti sottili, taglio continuo.

| | | | | | | | | | | | | | | | | | |
|-----------------|-------|-----|-----|------|-----|---|---|---|-----|------|-----|---|---|---|----|------|-----|
| CNMG 120404E-SF | T9415 | 0.4 | 315 | 0.17 | 1.0 | - | - | - | 295 | 0.17 | 1.0 | - | - | - | 60 | 0.13 | 0.3 |
|-----------------|-------|-----|-----|------|-----|---|---|---|-----|------|-----|---|---|---|----|------|-----|

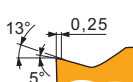

SM geometria con design positivo per medie lavorazioni, da taglio continuo a interrotto.

| | | | | | | | | | | | | | | | | | |
|-----------------|-------|-----|-----|------|-----|---|---|---|-----|------|-----|---|---|---|----|------|-----|
| CNMG 120404E-SM | T9415 | 0.4 | 280 | 0.20 | 2.0 | - | - | - | 265 | 0.20 | 2.0 | - | - | - | 55 | 0.13 | 0.3 |
| CNMG 120408E-SM | T9415 | 0.8 | 305 | 0.25 | 2.0 | - | - | - | 285 | 0.25 | 2.0 | - | - | - | 60 | 0.13 | 0.7 |
| CNMG 120412E-SM | T9415 | 1.2 | 300 | 0.30 | 2.0 | - | - | - | 285 | 0.30 | 2.0 | - | - | - | 60 | 0.15 | 1.0 |
| CNMG 160612E-SM | T9415 | 1.2 | 290 | 0.30 | 3.0 | - | - | - | 275 | 0.30 | 3.0 | - | - | - | 55 | 0.15 | 1.0 |
| CNMG 190612E-SM | T9415 | 1.2 | 280 | 0.30 | 4.0 | - | - | - | 265 | 0.30 | 4.0 | - | - | - | 55 | 0.15 | 1.0 |

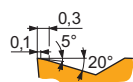
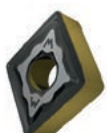

W-M geometria wiper per operazioni da semi sgrossatura fino a sgrossatura con maggiore velocità di avanzamento e finitura superficiale ottimizzata.

| | | | | | | | | | | | | | | | | | |
|----------------|-------|-----|-----|------|-----|---|---|---|-----|------|-----|---|---|---|---|---|---|
| CNMG 120408W-M | T9415 | 0.8 | 245 | 0.45 | 1.5 | - | - | - | 230 | 0.45 | 1.5 | - | - | - | - | - | - |
|----------------|-------|-----|-----|------|-----|---|---|---|-----|------|-----|---|---|---|---|---|---|



Idoneità e valori iniziali per velocità di taglio (Vc), avanzamento (f) e profondità di taglio (ap). Fare riferimento alla nostra App Machining Calculator per ulteriori calcoli.

| Prodotto | RE (mm) | P | | | M | | | K | | | N | | | S | | | H | | |
|----------|------------|---------------|---------------|------------|---------------|---------------|------------|---------------|---------------|------------|---------------|---------------|------------|---------------|---------------|------------|---------------|---------------|------------|
| | | vc (m/min) | f (mm/rev) | ap (mm) | vc (m/min) | f (mm/rev) | ap (mm) | vc (m/min) | f (mm/rev) | ap (mm) | vc (m/min) | f (mm/rev) | ap (mm) | vc (m/min) | f (mm/rev) | ap (mm) | vc (m/min) | f (mm/rev) | ap (mm) |

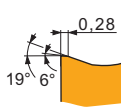
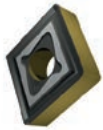

W-MR geometria wiper per operazioni da finitura fino a sgrossatura con maggiore velocità di avanzamento e finitura superficiale ottimizzata.

| | | | | | | | | | | | | | | | | | | | |
|-----------------|-------|-----|-----|------|-----|---|---|---|-----|------|-----|---|---|---|---|---|---|---|---|
| CNMG 120404W-MR | T9415 | 0.4 | 240 | 0.30 | 1.5 | — | — | — | 225 | 0.30 | 1.5 | — | — | — | — | — | — | — | — |
| CNMG 120408W-MR | T9415 | 0.8 | 245 | 0.45 | 1.5 | — | — | — | 230 | 0.45 | 1.5 | — | — | — | — | — | — | — | — |
| CNMG 120412W-MR | T9415 | 1.2 | 245 | 0.55 | 1.5 | — | — | — | 230 | 0.55 | 1.5 | — | — | — | — | — | — | — | — |

CNMM



| | IC (mm) | D1 (mm) | L (mm) | S (mm) |
|------|------------|------------|-----------|-----------|
| 1204 | 12.700 | 5.16 | 12.90 | 4.76 |
| 1606 | 15.875 | 6.35 | 16.10 | 6.35 |
| 1906 | 19.050 | 7.94 | 19.30 | 6.35 |
| 2509 | 25.400 | 9.12 | 25.80 | 9.53 |

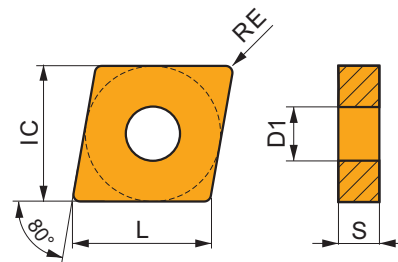

Idoneità e valori iniziali per velocità di taglio (Vc), avanzamento (f) e profondità di taglio (ap). Fare riferimento alla nostra App Machining Calculator per ulteriori calcoli.

| Prodotto | RE (mm) | P | | | M | | | K | | | N | | | S | | | H | | |
|----------|------------|---------------|---------------|------------|---------------|---------------|------------|---------------|---------------|------------|---------------|---------------|------------|---------------|---------------|------------|---------------|---------------|------------|
| | | vc (m/min) | f (mm/rev) | ap (mm) | vc (m/min) | f (mm/rev) | ap (mm) | vc (m/min) | f (mm/rev) | ap (mm) | vc (m/min) | f (mm/rev) | ap (mm) | vc (m/min) | f (mm/rev) | ap (mm) | vc (m/min) | f (mm/rev) | ap (mm) |

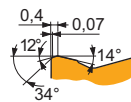
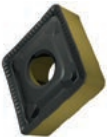

HR geometria per operazioni da sgrossatura fino a sgrossatura pesante, taglio continuo e interrotto.

| | | | | | | | | | | | | | | | | | | | |
|-----------------|-------|-----|-----|------|------|---|---|---|-----|------|------|---|---|---|---|---|---|---|---|
| CNMM 190624E-HR | T9415 | 2.4 | 120 | 0.65 | 10.0 | — | — | — | 110 | 0.65 | 10.0 | — | — | — | — | — | — | — | — |
| CNMM 250924E-HR | T9415 | 2.4 | 120 | 0.65 | 14.0 | — | — | — | 110 | 0.65 | 14.0 | — | — | — | — | — | — | — | — |

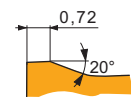
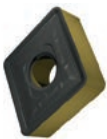

HR2 geometria per operazioni da sgrossatura fino a sgrossatura pesante, taglio continuo e interrotto.

| | | | | | | | | | | | | | | | | | | | |
|-----------------|-------|-----|-----|------|------|---|---|---|-----|------|------|---|---|---|---|---|---|---|---|
| CNMM 190616-HR2 | T9415 | 1.6 | 115 | 0.65 | 10.0 | — | — | — | 105 | 0.65 | 10.0 | — | — | — | — | — | — | — | — |
| CNMM 190624-HR2 | T9415 | 2.4 | 110 | 0.85 | 10.0 | — | — | — | 100 | 0.85 | 10.0 | — | — | — | — | — | — | — | — |
| CNMM 250924-HR2 | T9415 | 2.4 | 110 | 0.85 | 12.0 | — | — | — | 100 | 0.85 | 12.0 | — | — | — | — | — | — | — | — |

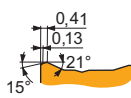
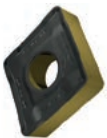

NR2 geometria per operazioni da semi sgrossatura fino a sgrossatura, da taglio continuo a interrotto.

| | | | | | | | | | | | | | | | | | | | |
|------------------|-------|-----|-----|------|------|---|---|---|-----|------|------|---|---|---|---|---|---|---|---|
| CNMM 120408E-NR2 | T9415 | 0.8 | 250 | 0.40 | 5.0 | — | — | — | 235 | 0.40 | 5.0 | — | — | — | — | — | — | — | — |
| CNMM 190616E-NR2 | T9415 | 1.6 | 240 | 0.50 | 9.0 | — | — | — | 225 | 0.50 | 9.0 | — | — | — | — | — | — | — | — |
| CNMM 250924E-NR2 | T9415 | 2.4 | 120 | 0.80 | 12.0 | — | — | — | 110 | 0.80 | 12.0 | — | — | — | — | — | — | — | — |

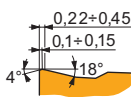

OR geometria per operazioni da semi sgrossatura fino a sgrossatura, da taglio continuo a interrotto.

| | | | | | | | | | | | | | | | | | | | |
|-----------------|-------|-----|-----|------|-----|---|---|---|-----|------|-----|---|---|---|---|---|---|---|---|
| CNMM 120408E-OR | T9415 | 0.8 | 250 | 0.40 | 5.0 | — | — | — | 235 | 0.40 | 5.0 | — | — | — | — | — | — | — | — |
| CNMM 120412E-OR | T9415 | 1.2 | 250 | 0.45 | 5.0 | — | — | — | 235 | 0.45 | 5.0 | — | — | — | — | — | — | — | — |
| CNMM 160608E-OR | T9415 | 0.8 | 245 | 0.40 | 6.0 | — | — | — | 230 | 0.40 | 6.0 | — | — | — | — | — | — | — | — |
| CNMM 160612E-OR | T9415 | 1.2 | 250 | 0.45 | 6.0 | — | — | — | 235 | 0.45 | 6.0 | — | — | — | — | — | — | — | — |
| CNMM 160616E-OR | T9415 | 1.6 | 250 | 0.50 | 6.0 | — | — | — | 235 | 0.50 | 6.0 | — | — | — | — | — | — | — | — |



Idoneità e valori iniziali per velocità di taglio (Vc), avanzamento (f) e profondità di taglio (ap). Fare riferimento alla nostra App Machining Calculator per ulteriori calcoli.

| Prodotto | RE (mm) | P | | | M | | | K | | | N | | | S | | | H | | |
|----------|------------|---------------|---------------|------------|---------------|---------------|------------|---------------|---------------|------------|---------------|---------------|------------|---------------|---------------|------------|---------------|---------------|------------|
| | | vc (m/min) | f (mm/rev) | ap (mm) | vc (m/min) | f (mm/rev) | ap (mm) | vc (m/min) | f (mm/rev) | ap (mm) | vc (m/min) | f (mm/rev) | ap (mm) | vc (m/min) | f (mm/rev) | ap (mm) | vc (m/min) | f (mm/rev) | ap (mm) |

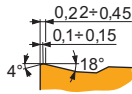
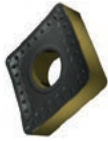

OR geometria per operazioni da semi sgrossatura fino a sgrossatura, da taglio continuo a interrotto.

| | | | | | | | | | | | | | | | | | | | |
|-----------------|-------|-----|-----|------|------|---|---|---|-----|------|------|---|---|---|---|---|---|---|---|
| CNMM 190612E-OR | T9415 | 1.2 | 240 | 0.45 | 9.0 | — | — | — | 225 | 0.45 | 9.0 | — | — | — | — | — | — | — | — |
| CNMM 190616E-OR | T9415 | 1.6 | 240 | 0.50 | 9.0 | — | — | — | 225 | 0.50 | 9.0 | — | — | — | — | — | — | — | — |
| CNMM 190624E-OR | T9415 | 2.4 | 215 | 0.80 | 9.0 | — | — | — | 200 | 0.80 | 9.0 | — | — | — | — | — | — | — | — |
| CNMM 250924E-OR | T9415 | 2.4 | 110 | 1.00 | 12.0 | — | — | — | 100 | 1.00 | 12.0 | — | — | — | — | — | — | — | — |

DCMT



| | IC (mm) | D1 (mm) | L (mm) | S (mm) |
|------|------------|------------|-----------|-----------|
| 0702 | 6.350 | 2.80 | 7.80 | 2.38 |
| 11T3 | 9.525 | 4.40 | 11.60 | 3.97 |
| 1504 | 12.700 | 5.50 | 15.50 | 4.76 |

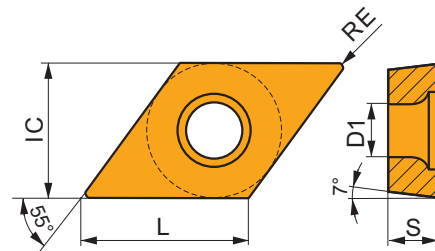

Idoneità e valori iniziali per velocità di taglio (Vc), avanzamento (f) e profondità di taglio (ap). Fare riferimento alla nostra App Machining Calculator per ulteriori calcoli.

| Prodotto | RE (mm) | P | | | M | | | K | | | N | | | S | | | H | | |
|----------|------------|---------------|---------------|------------|---------------|---------------|------------|---------------|---------------|------------|---------------|---------------|------------|---------------|---------------|------------|---------------|---------------|------------|
| | | vc (m/min) | f (mm/rev) | ap (mm) | vc (m/min) | f (mm/rev) | ap (mm) | vc (m/min) | f (mm/rev) | ap (mm) | vc (m/min) | f (mm/rev) | ap (mm) | vc (m/min) | f (mm/rev) | ap (mm) | vc (m/min) | f (mm/rev) | ap (mm) |

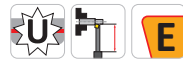
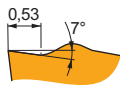

FF2 geometria positiva per operazioni da super finitura fino a finitura, da taglio continuo a leggermente interrotto.

| | | | | | | | | | | | | | | | | | | | |
|------------------|-------|-----|-----|------|-----|---|---|---|-----|------|-----|---|---|---|---|---|---|---|---|
| DCMT 070204E-FF2 | T9415 | 0.4 | 250 | 0.12 | 0.8 | — | — | — | 235 | 0.12 | 0.8 | — | — | — | — | — | — | — | — |
| DCMT 070208E-FF2 | T9415 | 0.8 | 265 | 0.17 | 0.8 | — | — | — | 250 | 0.17 | 0.8 | — | — | — | — | — | — | — | — |
| DCMT 11T304E-FF2 | T9415 | 0.4 | 250 | 0.12 | 0.8 | — | — | — | 235 | 0.12 | 0.8 | — | — | — | — | — | — | — | — |
| DCMT 11T308E-FF2 | T9415 | 0.8 | 265 | 0.17 | 0.8 | — | — | — | 250 | 0.17 | 0.8 | — | — | — | — | — | — | — | — |

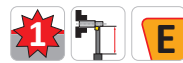

FM geometria per operazioni da finitura fino a semi sgrossatura, da taglio continuo a leggermente interrotto.

| | | | | | | | | | | | | | | | | | | | |
|-----------------|-------|-----|-----|------|-----|---|---|---|-----|------|-----|---|---|---|---|---|---|---|---|
| DCMT 070202E-FM | T9415 | 0.2 | 275 | 0.10 | 0.8 | — | — | — | 260 | 0.10 | 0.8 | — | — | — | — | — | — | — | — |
| DCMT 070204E-FM | T9415 | 0.4 | 275 | 0.12 | 0.8 | — | — | — | 260 | 0.12 | 0.8 | — | — | — | — | — | — | — | — |
| DCMT 11T302E-FM | T9415 | 0.2 | 275 | 0.10 | 0.8 | — | — | — | 260 | 0.10 | 0.8 | — | — | — | — | — | — | — | — |
| DCMT 11T304E-FM | T9415 | 0.4 | 275 | 0.12 | 0.8 | — | — | — | 260 | 0.12 | 0.8 | — | — | — | — | — | — | — | — |
| DCMT 11T308E-FM | T9415 | 0.8 | 290 | 0.17 | 0.8 | — | — | — | 275 | 0.17 | 0.8 | — | — | — | — | — | — | — | — |
| DCMT 11T312E-FM | T9415 | 1.2 | 265 | 0.22 | 1.2 | — | — | — | 250 | 0.22 | 1.2 | — | — | — | — | — | — | — | — |

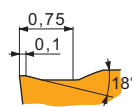

FM2 geometria per operazioni da finitura fino a lavorazioni medie, da taglio continuo a interrotto.

| | | | | | | | | | | | | | | | | | | | |
|------------------|-------|-----|-----|------|-----|---|---|---|-----|------|-----|---|---|---|---|---|---|---|---|
| DCMT 070204E-FM2 | T9415 | 0.4 | 250 | 0.12 | 0.8 | — | — | — | 235 | 0.12 | 0.8 | — | — | — | — | — | — | — | — |
| DCMT 11T304E-FM2 | T9415 | 0.4 | 250 | 0.12 | 0.8 | — | — | — | 235 | 0.12 | 0.8 | — | — | — | — | — | — | — | — |
| DCMT 11T308E-FM2 | T9415 | 0.8 | 265 | 0.17 | 0.8 | — | — | — | 250 | 0.17 | 0.8 | — | — | — | — | — | — | — | — |



Idoneità e valori iniziali per velocità di taglio (Vc), avanzamento (f) e profondità di taglio (ap). Fare riferimento alla nostra App Machining Calculator per ulteriori calcoli.

| Prodotto | RE (mm) | P | | | M | | | K | | | N | | | S | | | H | | |
|----------|------------|---------------|---------------|------------|---------------|---------------|------------|---------------|---------------|------------|---------------|---------------|------------|---------------|---------------|------------|---------------|---------------|------------|
| | | vc (m/min) | f (mm/rev) | ap (mm) | vc (m/min) | f (mm/rev) | ap (mm) | vc (m/min) | f (mm/rev) | ap (mm) | vc (m/min) | f (mm/rev) | ap (mm) | vc (m/min) | f (mm/rev) | ap (mm) | vc (m/min) | f (mm/rev) | ap (mm) |

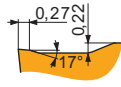

RM geometria per operazioni da semi sgrossatura fino a sgrossatura, da taglio continuo a interrotto.

| | | | | | | | | | | | | | | | | | | | | |
|-----------------|-------|-----|-----|------|-----|---|---|---|-----|------|-----|---|---|---|---|---|---|----|------|-----|
| DCMT 11T304E-RM | T9415 | 0.4 | 235 | 0.20 | 1.0 | - | - | - | 220 | 0.20 | 1.0 | - | - | - | - | - | - | 45 | 0.14 | 0.3 |
| DCMT 11T308E-RM | T9415 | 0.8 | 255 | 0.27 | 1.0 | - | - | - | 240 | 0.27 | 1.0 | - | - | - | - | - | - | 50 | 0.14 | 0.7 |
| DCMT 11T312E-RM | T9415 | 1.2 | 260 | 0.27 | 1.2 | - | - | - | 245 | 0.27 | 1.2 | - | - | - | - | - | - | 50 | 0.14 | 0.9 |
| DCMT 150408E-RM | T9415 | 0.8 | 235 | 0.27 | 1.9 | - | - | - | 220 | 0.27 | 1.9 | - | - | - | - | - | - | 45 | 0.14 | 0.7 |

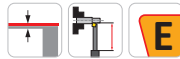
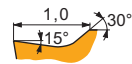

UR geometria per lavorazioni leggere e finitura, da taglio continuo a leggermente interrotto.

| | | | | | | | | | | | | | | | | | | | | |
|-----------------|-------|-----|-----|------|-----|---|---|---|-----|------|-----|---|---|---|---|---|---|---|---|---|
| DCMT 070202E-UR | T9415 | 0.2 | 235 | 0.10 | 0.8 | - | - | - | 220 | 0.10 | 0.8 | - | - | - | - | - | - | - | - | - |
| DCMT 070204E-UR | T9415 | 0.4 | 240 | 0.12 | 0.8 | - | - | - | 225 | 0.12 | 0.8 | - | - | - | - | - | - | - | - | - |
| DCMT 11T302E-UR | T9415 | 0.2 | 235 | 0.10 | 0.8 | - | - | - | 220 | 0.10 | 0.8 | - | - | - | - | - | - | - | - | - |
| DCMT 11T304E-UR | T9415 | 0.4 | 240 | 0.12 | 0.8 | - | - | - | 225 | 0.12 | 0.8 | - | - | - | - | - | - | - | - | - |
| DCMT 11T308E-UR | T9415 | 0.8 | 250 | 0.17 | 0.8 | - | - | - | 235 | 0.17 | 0.8 | - | - | - | - | - | - | - | - | - |
| DCMT 11T312E-UR | T9415 | 1.2 | 230 | 0.22 | 1.2 | - | - | - | 215 | 0.22 | 1.2 | - | - | - | - | - | - | - | - | - |

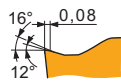

W-FM geometria wiper per lavorazioni leggere e finitura con maggiore velocità di avanzamento e finitura superficiale ottimizzata.

| | | | | | | | | | | | | | | | | | | | | |
|-----------------|-------|-----|-----|------|-----|---|---|---|-----|------|-----|---|---|---|---|---|---|---|---|---|
| DCMX 11T304W-FM | T9415 | 0.4 | 200 | 0.30 | 0.8 | - | - | - | 190 | 0.30 | 0.8 | - | - | - | - | - | - | - | - | - |
|-----------------|-------|-----|-----|------|-----|---|---|---|-----|------|-----|---|---|---|---|---|---|---|---|---|

DNMG



| | IC (mm) | D1 (mm) | L (mm) | S (mm) |
|------|------------|------------|-----------|-----------|
| 1104 | 9.525 | 3.81 | 11.60 | 4.76 |
| 1504 | 12.700 | 5.16 | 15.50 | 4.76 |
| 1506 | 12.700 | 5.16 | 15.50 | 6.35 |

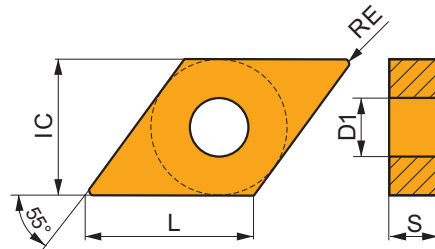

Idoneità e valori iniziali per velocità di taglio (Vc), avanzamento (f) e profondità di taglio (ap). Fare riferimento alla nostra App Machining Calculator per ulteriori calcoli.

| Prodotto | RE (mm) | P | | | M | | | K | | | N | | | S | | | H | | |
|----------|------------|---------------|---------------|------------|---------------|---------------|------------|---------------|---------------|------------|---------------|---------------|------------|---------------|---------------|------------|---------------|---------------|------------|
| | | vc (m/min) | f (mm/rev) | ap (mm) | vc (m/min) | f (mm/rev) | ap (mm) | vc (m/min) | f (mm/rev) | ap (mm) | vc (m/min) | f (mm/rev) | ap (mm) | vc (m/min) | f (mm/rev) | ap (mm) | vc (m/min) | f (mm/rev) | ap (mm) |

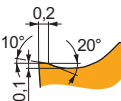

FM geometria positiva per operazioni da finitura fino a semi sgrossatura, da taglio continuo a leggermente interrotto.

| | | | | | | | | | | | | | | | | | | | | |
|-----------------|-------|-----|-----|------|-----|---|---|---|-----|------|-----|---|---|---|---|---|---|---|---|---|
| DNMG 110404E-FM | T9415 | 0.4 | 260 | 0.20 | 0.8 | - | - | - | 245 | 0.20 | 0.8 | - | - | - | - | - | - | - | - | - |
| DNMG 110408E-FM | T9415 | 0.8 | 305 | 0.20 | 0.8 | - | - | - | 285 | 0.20 | 0.8 | - | - | - | - | - | - | - | - | - |
| DNMG 150404E-FM | T9415 | 0.4 | 235 | 0.20 | 1.7 | - | - | - | 220 | 0.20 | 1.7 | - | - | - | - | - | - | - | - | - |
| DNMG 150408E-FM | T9415 | 0.8 | 280 | 0.20 | 1.7 | - | - | - | 265 | 0.20 | 1.7 | - | - | - | - | - | - | - | - | - |
| DNMG 150604E-FM | T9415 | 0.4 | 235 | 0.20 | 1.7 | - | - | - | 220 | 0.20 | 1.7 | - | - | - | - | - | - | - | - | - |
| DNMG 150608E-FM | T9415 | 0.8 | 280 | 0.20 | 1.7 | - | - | - | 265 | 0.20 | 1.7 | - | - | - | - | - | - | - | - | - |
| DNMG 150612E-FM | T9415 | 1.2 | 275 | 0.25 | 1.7 | - | - | - | 260 | 0.25 | 1.7 | - | - | - | - | - | - | - | - | - |
| DNMG 150616E-FM | T9415 | 1.6 | 270 | 0.30 | 1.7 | - | - | - | 255 | 0.30 | 1.7 | - | - | - | - | - | - | - | - | - |



Idoneità e valori iniziali per velocità di taglio (Vc), avanzamento (f) e profondità di taglio (ap). Fare riferimento alla nostra App Machining Calculator per ulteriori calcoli.

| Prodotto | RE (mm) | P | | | M | | | K | | | N | | | S | | | H | | |
|----------|------------|---------------|---------------|------------|---------------|---------------|------------|---------------|---------------|------------|---------------|---------------|------------|---------------|---------------|------------|---------------|---------------|------------|
| | | vc (m/min) | f (mm/rev) | ap (mm) | vc (m/min) | f (mm/rev) | ap (mm) | vc (m/min) | f (mm/rev) | ap (mm) | vc (m/min) | f (mm/rev) | ap (mm) | vc (m/min) | f (mm/rev) | ap (mm) | vc (m/min) | f (mm/rev) | ap (mm) |

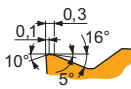

M geometria per operazioni da finitura fino a semi sgrossatura, da taglio continuo a interrotto.

| | | | | | | | | | | | | | | | | | | | | |
|----------------|-------|-----|-----|------|-----|---|---|---|-----|------|-----|---|---|---|---|---|---|----|------|-----|
| DNMG 110404E-M | T9415 | 0.4 | 225 | 0.20 | 1.2 | - | - | - | 210 | 0.20 | 1.2 | - | - | - | - | - | - | 45 | 0.14 | 0.3 |
| DNMG 110408E-M | T9415 | 0.8 | 235 | 0.30 | 1.2 | - | - | - | 220 | 0.30 | 1.2 | - | - | - | - | - | - | 45 | 0.15 | 0.7 |
| DNMG 110412E-M | T9415 | 1.2 | 220 | 0.40 | 1.2 | - | - | - | 205 | 0.40 | 1.2 | - | - | - | - | - | - | 40 | 0.20 | 0.9 |
| DNMG 150404E-M | T9415 | 0.4 | 210 | 0.20 | 1.9 | - | - | - | 195 | 0.20 | 1.9 | - | - | - | - | - | - | 40 | 0.14 | 0.3 |
| DNMG 150408E-M | T9415 | 0.8 | 220 | 0.30 | 1.9 | - | - | - | 205 | 0.30 | 1.9 | - | - | - | - | - | - | 40 | 0.15 | 0.7 |
| DNMG 150412E-M | T9415 | 1.2 | 210 | 0.40 | 1.9 | - | - | - | 195 | 0.40 | 1.9 | - | - | - | - | - | - | 40 | 0.20 | 0.9 |
| DNMG 150604E-M | T9415 | 0.4 | 210 | 0.20 | 1.9 | - | - | - | 195 | 0.20 | 1.9 | - | - | - | - | - | - | 40 | 0.14 | 0.3 |
| DNMG 150608E-M | T9415 | 0.8 | 220 | 0.30 | 1.9 | - | - | - | 205 | 0.30 | 1.9 | - | - | - | - | - | - | 40 | 0.15 | 0.7 |
| DNMG 150612E-M | T9415 | 1.2 | 210 | 0.40 | 1.9 | - | - | - | 195 | 0.40 | 1.9 | - | - | - | - | - | - | 40 | 0.20 | 0.9 |

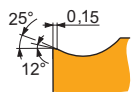

NF geometria con design altamente positivo per operazioni da finitura fino a medie lavorazioni, taglio continuo.

| | | | | | | | | | | | | | | | | | | | | |
|-----------------|-------|-----|-----|------|-----|---|---|---|-----|------|-----|---|---|---|---|---|---|---|---|---|
| DNMG 110408E-NF | T9415 | 0.8 | 315 | 0.17 | 1.0 | - | - | - | 295 | 0.17 | 1.0 | - | - | - | - | - | - | - | - | - |
| DNMG 150404E-NF | T9415 | 0.4 | 260 | 0.15 | 1.7 | - | - | - | 245 | 0.15 | 1.7 | - | - | - | - | - | - | - | - | - |
| DNMG 150408E-NF | T9415 | 0.8 | 300 | 0.17 | 1.7 | - | - | - | 285 | 0.17 | 1.7 | - | - | - | - | - | - | - | - | - |
| DNMG 150604E-NF | T9415 | 0.4 | 260 | 0.15 | 1.9 | - | - | - | 245 | 0.15 | 1.9 | - | - | - | - | - | - | - | - | - |
| DNMG 150608E-NF | T9415 | 0.8 | 295 | 0.17 | 1.9 | - | - | - | 280 | 0.17 | 1.9 | - | - | - | - | - | - | - | - | - |

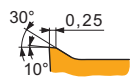

NM geometria con design altamente positivo per operazioni di finitura, media sgrossatura, taglio continuo.

| | | | | | | | | | | | | | | | | | | | | |
|-----------------|-------|-----|-----|------|-----|---|---|---|---|---|---|---|---|---|---|---|---|---|---|---|
| DNMG 150608E-NM | T9415 | 0.8 | 275 | 0.25 | 1.9 | - | - | - | - | - | - | - | - | - | - | - | - | - | - | - |
|-----------------|-------|-----|-----|------|-----|---|---|---|---|---|---|---|---|---|---|---|---|---|---|---|

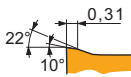

NMR geometria con design positivo per operazioni da media fino a sgrossatura, taglio continuo.

| | | | | | | | | | | | | | | | | | | | |
|------------------|-------|-----|-----|------|-----|---|---|---|---|---|---|---|---|---|---|---|---|---|---|
| DNMG 110408E-NMR | T9415 | 0.8 | 240 | 0.30 | 0.8 | - | - | - | - | - | - | - | - | - | - | - | - | - | - |
| DNMG 150408E-NMR | T9415 | 0.8 | 220 | 0.30 | 1.9 | - | - | - | - | - | - | - | - | - | - | - | - | - | - |
| DNMG 150604E-NMR | T9415 | 0.4 | 210 | 0.20 | 1.9 | - | - | - | - | - | - | - | - | - | - | - | - | - | - |
| DNMG 150608E-NMR | T9415 | 0.8 | 220 | 0.30 | 1.9 | - | - | - | - | - | - | - | - | - | - | - | - | - | - |
| DNMG 150612E-NMR | T9415 | 1.2 | 235 | 0.30 | 1.9 | - | - | - | - | - | - | - | - | - | - | - | - | - | - |

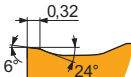

NRM geometria con design positivo per operazioni da semi sgrossatura fino a sgrossatura, da taglio continuo a moderatamente interrotto.

| | | | | | | | | | | | | | | | | | | | |
|-----------------|-------|-----|-----|------|-----|---|---|---|---|---|---|---|---|---|---|---|---|---|---|
| DNMG 150608-NRM | T9415 | 0.8 | 210 | 0.30 | 3.0 | - | - | - | - | - | - | - | - | - | - | - | - | - | - |
|-----------------|-------|-----|-----|------|-----|---|---|---|---|---|---|---|---|---|---|---|---|---|---|

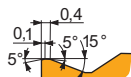

R geometria per operazioni da semi sgrossatura fino a sgrossatura, da taglio continuo a interrotto.

| | | | | | | | | | | | | | | | | | | | | |
|----------------|-------|-----|-----|------|-----|---|---|---|-----|------|-----|---|---|---|---|---|---|----|------|-----|
| DNMG 150608E-R | T9415 | 0.8 | 190 | 0.40 | 3.0 | - | - | - | 180 | 0.40 | 3.0 | - | - | - | - | - | - | 35 | 0.20 | 0.7 |
| DNMG 150612E-R | T9415 | 1.2 | 200 | 0.40 | 3.0 | - | - | - | 190 | 0.40 | 3.0 | - | - | - | - | - | - | 40 | 0.20 | 0.9 |

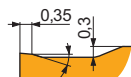

RM geometria per operazioni da semi sgrossatura fino a sgrossatura, da taglio continuo a interrotto.

| | | | | | | | | | | | | | | | | | | | |
|-----------------|-------|-----|-----|------|-----|---|---|---|-----|------|-----|---|---|---|---|---|---|---|---|
| DNMG 110408E-RM | T9415 | 0.8 | 230 | 0.40 | 2.0 | - | - | - | 215 | 0.40 | 2.0 | - | - | - | - | - | - | - | - |
| DNMG 110412E-RM | T9415 | 1.2 | 265 | 0.30 | 2.0 | - | - | - | 250 | 0.30 | 2.0 | - | - | - | - | - | - | - | - |
| DNMG 150408E-RM | T9415 | 0.8 | 220 | 0.40 | 3.0 | - | - | - | 205 | 0.40 | 3.0 | - | - | - | - | - | - | - | - |
| DNMG 150412E-RM | T9415 | 1.2 | 230 | 0.40 | 3.0 | - | - | - | 215 | 0.40 | 3.0 | - | - | - | - | - | - | - | - |



Idoneità e valori iniziali per velocità di taglio (Vc), avanzamento (f) e profondità di taglio (ap). Fare riferimento alla nostra App Machining Calculator per ulteriori calcoli.

| Prodotto | RE (mm) | P | | | M | | | K | | | N | | | S | | | H | | |
|----------|------------|---------------|---------------|------------|---------------|---------------|------------|---------------|---------------|------------|---------------|---------------|------------|---------------|---------------|------------|---------------|---------------|------------|
| | | vc (m/min) | f (mm/rev) | ap (mm) | vc (m/min) | f (mm/rev) | ap (mm) | vc (m/min) | f (mm/rev) | ap (mm) | vc (m/min) | f (mm/rev) | ap (mm) | vc (m/min) | f (mm/rev) | ap (mm) | vc (m/min) | f (mm/rev) | ap (mm) |

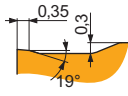

RM geometria per operazioni da semi sgrossatura fino a sgrossatura, da taglio continuo a interrotto.

| | | | | | | | | | | | | | | | | | | | |
|-----------------|-------|-----|-----|------|-----|---|---|---|-----|------|-----|---|---|---|---|---|---|---|---|
| DNMG 150608E-RM | T9415 | 0.8 | 220 | 0.40 | 3.0 | — | — | — | 205 | 0.40 | 3.0 | — | — | — | — | — | — | — | — |
| DNMG 150612E-RM | T9415 | 1.2 | 230 | 0.40 | 3.0 | — | — | — | 215 | 0.40 | 3.0 | — | — | — | — | — | — | — | — |
| DNMG 150616E-RM | T9415 | 1.6 | 245 | 0.40 | 3.0 | — | — | — | 230 | 0.40 | 3.0 | — | — | — | — | — | — | — | — |

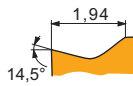

SF geometria con design positivo per operazioni di finitura su pareti sottili, taglio continuo.

| | | | | | | | | | | | | | | | | | | | |
|-----------------|-------|-----|-----|------|-----|---|---|---|-----|------|-----|---|---|---|---|---|----|------|-----|
| DNMG 150608E-SF | T9415 | 0.8 | 290 | 0.17 | 1.5 | — | — | — | 275 | 0.17 | 1.5 | — | — | — | — | — | 55 | 0.12 | 0.7 |
|-----------------|-------|-----|-----|------|-----|---|---|---|-----|------|-----|---|---|---|---|---|----|------|-----|

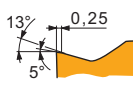

SM geometria con design positivo per medie lavorazioni, da taglio continuo a interrotto.

| | | | | | | | | | | | | | | | | | | | |
|-----------------|-------|-----|-----|------|-----|---|---|---|-----|------|-----|---|---|---|---|---|----|------|-----|
| DNMG 150604E-SM | T9415 | 0.4 | 225 | 0.20 | 1.7 | — | — | — | 210 | 0.20 | 1.7 | — | — | — | — | — | 45 | 0.14 | 0.3 |
| DNMG 150608E-SM | T9415 | 0.8 | 250 | 0.25 | 1.7 | — | — | — | 235 | 0.25 | 1.7 | — | — | — | — | — | 50 | 0.13 | 0.7 |
| DNMG 150612E-SM | T9415 | 1.2 | 245 | 0.30 | 1.7 | — | — | — | 230 | 0.30 | 1.7 | — | — | — | — | — | 45 | 0.15 | 0.9 |

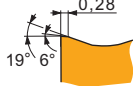
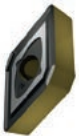

W-MR geometria wiper per operazioni da finitura fino a sgrossatura con maggiore velocità di avanzamento e finitura superficiale ottimizzata.

| | | | | | | | | | | | | | | | | | | | |
|-----------------|-------|-----|-----|------|-----|---|---|---|-----|------|-----|---|---|---|---|---|---|---|---|
| DNMG 150608W-MR | T9415 | 0.8 | 205 | 0.40 | 1.5 | — | — | — | 190 | 0.40 | 1.5 | — | — | — | — | — | — | — | — |
| DNMG 150612W-MR | T9415 | 1.2 | 200 | 0.50 | 1.5 | — | — | — | 190 | 0.50 | 1.5 | — | — | — | — | — | — | — | — |

DNMM



| | IC (mm) | D1 (mm) | L (mm) | S (mm) |
|------|------------|------------|-----------|-----------|
| 1506 | 12.700 | 5.16 | 15.50 | 6.35 |

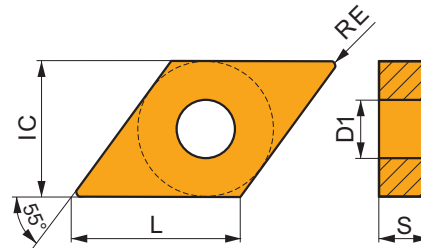

Idoneità e valori iniziali per velocità di taglio (Vc), avanzamento (f) e profondità di taglio (ap). Fare riferimento alla nostra App Machining Calculator per ulteriori calcoli.

| Prodotto | RE (mm) | P | | | M | | | K | | | N | | | S | | | H | | |
|----------|------------|---------------|---------------|------------|---------------|---------------|------------|---------------|---------------|------------|---------------|---------------|------------|---------------|---------------|------------|---------------|---------------|------------|
| | | vc (m/min) | f (mm/rev) | ap (mm) | vc (m/min) | f (mm/rev) | ap (mm) | vc (m/min) | f (mm/rev) | ap (mm) | vc (m/min) | f (mm/rev) | ap (mm) | vc (m/min) | f (mm/rev) | ap (mm) | vc (m/min) | f (mm/rev) | ap (mm) |

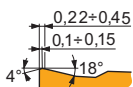

OR geometria per operazioni da semi sgrossatura fino a sgrossatura, da taglio continuo a interrotto.

| | | | | | | | | | | | | | | | | | | | |
|-----------------|-------|-----|-----|------|-----|---|---|---|-----|------|-----|---|---|---|---|---|---|---|---|
| DNMM 150612E-OR | T9415 | 1.2 | 220 | 0.40 | 3.0 | — | — | — | 205 | 0.40 | 3.0 | — | — | — | — | — | — | — | — |
|-----------------|-------|-----|-----|------|-----|---|---|---|-----|------|-----|---|---|---|---|---|---|---|---|



ECMT

| | IC (mm) | D1 (mm) | L (mm) | S (mm) |
|------|------------|------------|-----------|-----------|
| 0602 | 6.350 | 2.80 | 6.50 | 2.38 |
| 0803 | 7.940 | 3.40 | 8.20 | 3.18 |

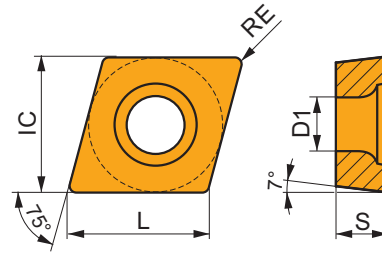

Idoneità e valori iniziali per velocità di taglio (Vc), avanzamento (f) e profondità di taglio (ap). Fare riferimento alla nostra App Machining Calculator per ulteriori calcoli.

| Prodotto | RE (mm) | P | | | M | | | K | | | N | | | S | | | H | | |
|----------|------------|---------------|---------------|------------|---------------|---------------|------------|---------------|---------------|------------|---------------|---------------|------------|---------------|---------------|------------|---------------|---------------|------------|
| | | vc (m/min) | f (mm/rev) | ap (mm) | vc (m/min) | f (mm/rev) | ap (mm) | vc (m/min) | f (mm/rev) | ap (mm) | vc (m/min) | f (mm/rev) | ap (mm) | vc (m/min) | f (mm/rev) | ap (mm) | vc (m/min) | f (mm/rev) | ap (mm) |

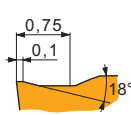
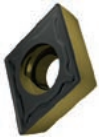

FM2 geometria per operazioni da finitura fino a lavorazioni medie, da taglio continuo a interrotto.

| | | | | | | | | | | | | | | | | | | | |
|------------------|-------|-----|-----|------|-----|---|---|---|-----|------|-----|---|---|---|---|---|---|---|---|
| ECMT 060204E-FM2 | T9415 | 0.4 | 285 | 0.12 | 0.8 | — | — | — | 270 | 0.12 | 0.8 | — | — | — | — | — | — | — | — |
| ECMT 080304E-FM2 | T9415 | 0.4 | 275 | 0.12 | 1.0 | — | — | — | 260 | 0.12 | 1.0 | — | — | — | — | — | — | — | — |
| ECMT 080308E-FM2 | T9415 | 0.8 | 290 | 0.17 | 1.0 | — | — | — | 275 | 0.17 | 1.0 | — | — | — | — | — | — | — | — |

EPMT

| | IC (mm) | D1 (mm) | L (mm) | S (mm) |
|------|------------|------------|-----------|-----------|
| 0502 | 5.560 | 2.50 | 5.70 | 2.38 |

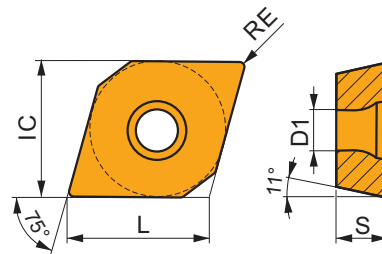

Idoneità e valori iniziali per velocità di taglio (Vc), avanzamento (f) e profondità di taglio (ap). Fare riferimento alla nostra App Machining Calculator per ulteriori calcoli.

| Prodotto | RE (mm) | P | | | M | | | K | | | N | | | S | | | H | | |
|----------|------------|---------------|---------------|------------|---------------|---------------|------------|---------------|---------------|------------|---------------|---------------|------------|---------------|---------------|------------|---------------|---------------|------------|
| | | vc (m/min) | f (mm/rev) | ap (mm) | vc (m/min) | f (mm/rev) | ap (mm) | vc (m/min) | f (mm/rev) | ap (mm) | vc (m/min) | f (mm/rev) | ap (mm) | vc (m/min) | f (mm/rev) | ap (mm) | vc (m/min) | f (mm/rev) | ap (mm) |



NF2 geometria con design positivo per operazioni da finitura e semi sgrossatura, taglio continuo.

| | | | | | | | | | | | | | | | | | | | |
|------------------|-------|-----|-----|------|-----|---|---|---|-----|------|-----|---|---|---|---|---|---|---|---|
| EPMT 050202E-NF2 | T9415 | 0.2 | 355 | 0.05 | 0.8 | — | — | — | 335 | 0.05 | 0.8 | — | — | — | — | — | — | — | — |
|------------------|-------|-----|-----|------|-----|---|---|---|-----|------|-----|---|---|---|---|---|---|---|---|



RCMT



|  | INSD (mm) | D1 (mm) | S (mm) |
|---|--------------|------------|-----------|
| 0602 | 6.000 | 2.80 | 2.38 |
| 0803 | 8.000 | 3.40 | 3.18 |
| 10T3 | 10.000 | 4.40 | 3.97 |
| 1204 | 12.000 | 4.40 | 4.76 |
| 1606 | 16.000 | 5.50 | 6.35 |
| 2006 | 20.000 | 6.50 | 6.35 |
| 3009 | 30.000 | 10.00 | 9.53 |

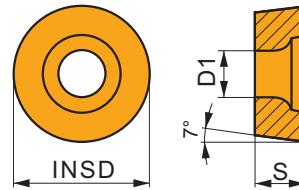

Idoneità e valori iniziali per velocità di taglio (Vc), avanzamento (f) e profondità di taglio (ap). Fare riferimento alla nostra App Machining Calculator per ulteriori calcoli.

| Prodotto | RE (mm) | P | | | M | | | K | | | N | | | S | | | H | | |
|----------|------------|---------------|---------------|------------|---------------|---------------|------------|---------------|---------------|------------|---------------|---------------|------------|---------------|---------------|------------|---------------|---------------|------------|
| | | vc (m/min) | f (mm/rev) | ap (mm) | vc (m/min) | f (mm/rev) | ap (mm) | vc (m/min) | f (mm/rev) | ap (mm) | vc (m/min) | f (mm/rev) | ap (mm) | vc (m/min) | f (mm/rev) | ap (mm) | vc (m/min) | f (mm/rev) | ap (mm) |

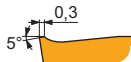
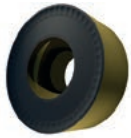

37 geometria per operazioni da semi sgrossatura fino a sgrossatura pesante, da taglio continuo a interrotto.

| | | | | | | | | | | | | | | | | | | | |
|-----------------|-------|---|-----|------|-----|---|---|---|-----|------|-----|---|---|---|---|---|---|---|---|
| RCMT 1606MOS-37 | T9415 | - | 200 | 0.60 | 3.0 | - | - | - | 190 | 0.60 | 3.0 | - | - | - | - | - | - | - | - |
|-----------------|-------|---|-----|------|-----|---|---|---|-----|------|-----|---|---|---|---|---|---|---|---|

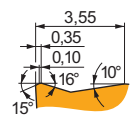

371 geometria per operazioni da semi sgrossatura fino a sgrossatura pesante, da taglio continuo a interrotto.

| | | | | | | | | | | | | | | | | | | | |
|------------------|-------|---|-----|------|-----|---|---|---|-----|------|-----|---|---|---|---|---|---|---|---|
| RCMT 2006MOS-371 | T9415 | - | 185 | 0.80 | 3.0 | - | - | - | 175 | 0.80 | 3.0 | - | - | - | - | - | - | - | - |
|------------------|-------|---|-----|------|-----|---|---|---|-----|------|-----|---|---|---|---|---|---|---|---|

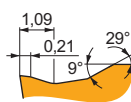

FM geometria per operazioni da finitura fino a semi sgrossatura, da taglio continuo a leggermente interrotto.

| | | | | | | | | | | | | | | | | | | | |
|-----------------|-------|---|-----|------|-----|---|---|---|-----|------|-----|---|---|---|---|---|---|---|---|
| RCMT 0602MOE-FM | T9415 | - | 320 | 0.45 | 1.2 | - | - | - | 300 | 0.45 | 1.2 | - | - | - | - | - | - | - | - |
| RCMT 0803MOE-FM | T9415 | - | 280 | 0.60 | 1.6 | - | - | - | 265 | 0.60 | 1.6 | - | - | - | - | - | - | - | - |
| RCMT 10T3MOE-FM | T9415 | - | 275 | 0.65 | 1.7 | - | - | - | 260 | 0.65 | 1.7 | - | - | - | - | - | - | - | - |
| RCMT 1204MOE-FM | T9415 | - | 260 | 0.70 | 1.8 | - | - | - | 245 | 0.70 | 1.8 | - | - | - | - | - | - | - | - |

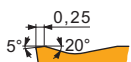
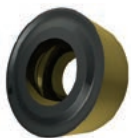

RM3 geometria per operazioni da semi sgrossatura fino a sgrossatura, da taglio continuo a interrotto.

| | | | | | | | | | | | | | | | | | | | |
|------------------|-------|---|-----|------|-----|---|---|---|-----|------|-----|---|---|---|---|---|----|------|-----|
| RCMT 0803MOE-RM3 | T9415 | - | 275 | 0.50 | 1.3 | - | - | - | 260 | 0.50 | 1.3 | - | - | - | - | - | 55 | 0.25 | 0.5 |
| RCMT 1204MOE-RM3 | T9415 | - | 255 | 0.60 | 1.8 | - | - | - | 240 | 0.60 | 1.8 | - | - | - | - | - | 50 | 0.30 | 0.8 |
| RCMT 1606MOE-RM3 | T9415 | - | 245 | 0.65 | 2.0 | - | - | - | 230 | 0.65 | 2.0 | - | - | - | - | - | 45 | 0.33 | 1.1 |

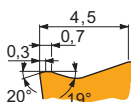
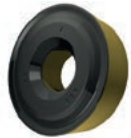

RR4 geometria per operazioni di sgrossatura pesante, taglio continuo e interrotto.

| | | | | | | | | | | | | | | | | | | | |
|-----------------|-------|---|----|------|-----|---|---|---|----|------|-----|---|---|---|---|---|---|---|---|
| RCMT 3009MO-RR4 | T9415 | - | 95 | 1.10 | 4.0 | - | - | - | 90 | 1.10 | 4.0 | - | - | - | - | - | - | - | - |
|-----------------|-------|---|----|------|-----|---|---|---|----|------|-----|---|---|---|---|---|---|---|---|

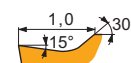
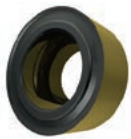

UR geometria per lavorazioni leggere e finitura, da taglio continuo a leggermente interrotto.

| | | | | | | | | | | | | | | | | | | | |
|-----------------|-------|---|-----|------|-----|---|---|---|-----|------|-----|---|---|---|---|---|---|---|---|
| RCMT 0602MOE-UR | T9415 | - | 285 | 0.40 | 1.2 | - | - | - | 270 | 0.40 | 1.2 | - | - | - | - | - | - | - | - |
| RCMT 0803MOE-UR | T9415 | - | 265 | 0.45 | 1.6 | - | - | - | 250 | 0.45 | 1.6 | - | - | - | - | - | - | - | - |
| RCMT 10T3MOE-UR | T9415 | - | 260 | 0.50 | 1.4 | - | - | - | 245 | 0.50 | 1.4 | - | - | - | - | - | - | - | - |
| RCMT 1204MOE-UR | T9415 | - | 245 | 0.55 | 1.8 | - | - | - | 230 | 0.55 | 1.8 | - | - | - | - | - | - | - | - |



RCMX



| | INSD (mm) | D1 (mm) | S (mm) |
|------|--------------|------------|-----------|
| 1204 | 12.000 | 4.20 | 4.76 |
| 1606 | 16.000 | 5.20 | 6.35 |
| 2006 | 20.000 | 6.50 | 6.35 |
| 2507 | 25.000 | 7.20 | 7.94 |
| 3209 | 32.000 | 9.50 | 9.53 |

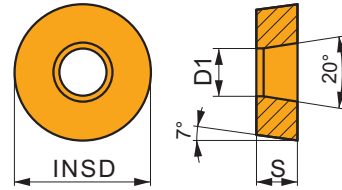

Idoneità e valori iniziali per velocità di taglio (Vc), avanzamento (f) e profondità di taglio (ap). Fare riferimento alla nostra App Machining Calculator per ulteriori calcoli.

| Prodotto | RE (mm) | P | | | M | | | K | | | N | | | S | | | H | | | |
|-------------------------|--------------|---------------|---------------|------------|---------------|---------------|------------|---------------|---------------|------------|---------------|---------------|------------|---------------|---------------|------------|---------------|---------------|------------|-----|
| | | vc (m/min) | f (mm/rev) | ap (mm) | vc (m/min) | f (mm/rev) | ap (mm) | vc (m/min) | f (mm/rev) | ap (mm) | vc (m/min) | f (mm/rev) | ap (mm) | vc (m/min) | f (mm/rev) | ap (mm) | vc (m/min) | f (mm/rev) | ap (mm) | |
| | | | | | | | | | | | | | | | | | | | | |
| RCMX 1606M05-37 | T9415 | - | 200 | 0.60 | 3.0 | - | - | - | 190 | 0.60 | 3.0 | - | - | - | - | - | - | - | - | |
| | | | | | | | | | | | | | | | | | | | | |
| RCMX 1204M05-321 | T9415 | - | 170 | 1.00 | 3.0 | - | - | - | 160 | 1.00 | 3.0 | - | - | - | - | - | - | - | - | |
| | | | | | | | | | | | | | | | | | | | | |
| RCMX 1606M05-331 | T9415 | - | 155 | 1.20 | 3.5 | - | - | - | 145 | 1.20 | 3.5 | - | - | - | - | - | - | - | - | |
| | | | | | | | | | | | | | | | | | | | | |
| RCMX 2006M0-RF1 | T9415 | - | 105 | 0.80 | 3.5 | - | - | - | 95 | 0.80 | 3.5 | - | - | - | - | - | - | - | - | |
| RCMX 2507M0-RF1 | T9415 | - | 100 | 1.00 | 3.5 | - | - | - | 95 | 1.00 | 3.5 | - | - | - | - | - | - | - | - | |
| | | | | | | | | | | | | | | | | | | | | |
| RCMX 2006M0-RM1 | T9415 | - | 100 | 1.00 | 3.5 | - | - | - | 95 | 1.00 | 3.5 | - | - | - | - | - | - | - | - | |
| RCMX 2507M0-RM1 | T9415 | - | 100 | 1.00 | 3.5 | - | - | - | 95 | 1.00 | 3.5 | - | - | - | - | - | - | - | - | |
| | | | | | | | | | | | | | | | | | | | | |
| RCMX 2507M0-RM2 | T9415 | - | 95 | 1.10 | 3.5 | - | - | - | 90 | 1.10 | 3.5 | - | - | - | - | - | - | - | - | |
| RCMX 3209M0-RM2 | T9415 | - | 95 | 1.00 | 4.5 | - | - | - | 90 | 1.00 | 4.5 | - | - | - | - | - | - | - | - | |
| | | | | | | | | | | | | | | | | | | | | |
| RCMX 3209M0-RR2 | T9415 | - | 70 | 1.40 | 4.5 | - | - | - | 65 | 1.40 | 4.5 | - | - | - | - | - | - | 10 | 0.70 | 2.0 |



RNMG

PRAMET

| | INSD (mm) | D1 (mm) | S (mm) |
|------|--------------|------------|-----------|
| 1204 | 12.700 | 5.16 | 4.76 |
| 1506 | 15.875 | 6.35 | 6.35 |
| 1906 | 19.050 | 7.94 | 6.35 |
| 2509 | 25.400 | 9.12 | 9.53 |

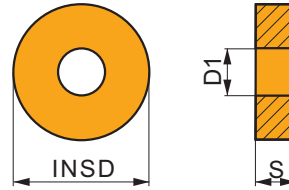

Idoneità e valori iniziali per velocità di taglio (Vc), avanzamento (f) e profondità di taglio (ap). Fare riferimento alla nostra App Machining Calculator per ulteriori calcoli.

| Prodotto | RE (mm) | P | | | M | | | K | | | N | | | S | | | H | | |
|----------|------------|---------------|---------------|------------|---------------|---------------|------------|---------------|---------------|------------|---------------|---------------|------------|---------------|---------------|------------|---------------|---------------|------------|
| | | vc (m/min) | f (mm/rev) | ap (mm) | vc (m/min) | f (mm/rev) | ap (mm) | vc (m/min) | f (mm/rev) | ap (mm) | vc (m/min) | f (mm/rev) | ap (mm) | vc (m/min) | f (mm/rev) | ap (mm) | vc (m/min) | f (mm/rev) | ap (mm) |

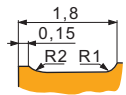
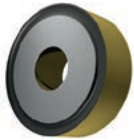

08 geometria per operazioni da semi sgrossatura fino a sgrossatura pesante, da taglio continuo a interrotto.

| | | | | | | | | | | | | | | | | | | | | |
|-----------------|-------|---|-----|------|-----|---|---|---|-----|------|-----|---|---|---|---|---|---|----|------|-----|
| RNMG 120400E-08 | T9415 | - | 190 | 0.70 | 3.0 | - | - | - | 180 | 0.70 | 3.0 | - | - | - | - | - | - | 35 | 0.35 | 0.8 |
| RNMG 150600E-08 | T9415 | - | 190 | 0.70 | 3.0 | - | - | - | 180 | 0.70 | 3.0 | - | - | - | - | - | - | 35 | 0.35 | 1.0 |
| RNMG 190600E-08 | T9415 | - | 190 | 0.70 | 3.0 | - | - | - | 180 | 0.70 | 3.0 | - | - | - | - | - | - | 35 | 0.35 | 1.3 |

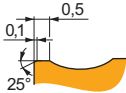
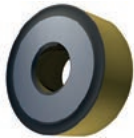

081 geometria per operazioni da sgrossatura fino a sgrossatura pesante, da taglio continuo a interrotto.

| | | | | | | | | | | | | | | | | | | | | |
|------------------|-------|---|-----|------|-----|---|---|---|----|------|-----|---|---|---|---|---|---|----|------|-----|
| RNMG 250900E-081 | T9415 | - | 100 | 0.90 | 5.0 | - | - | - | 95 | 0.90 | 5.0 | - | - | - | - | - | - | 20 | 0.45 | 1.7 |
|------------------|-------|---|-----|------|-----|---|---|---|----|------|-----|---|---|---|---|---|---|----|------|-----|

SCMT

PRAMET

| | IC (mm) | D1 (mm) | L (mm) | S (mm) |
|------|------------|------------|-----------|-----------|
| 09T3 | 9.525 | 4.40 | 9.53 | 3.97 |
| 1204 | 12.700 | 5.50 | 12.70 | 4.76 |

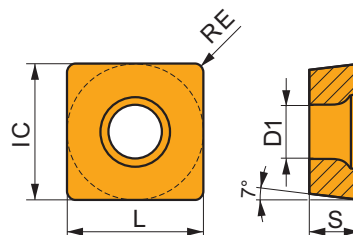

Idoneità e valori iniziali per velocità di taglio (Vc), avanzamento (f) e profondità di taglio (ap). Fare riferimento alla nostra App Machining Calculator per ulteriori calcoli.

| Prodotto | RE (mm) | P | | | M | | | K | | | N | | | S | | | H | | |
|----------|------------|---------------|---------------|------------|---------------|---------------|------------|---------------|---------------|------------|---------------|---------------|------------|---------------|---------------|------------|---------------|---------------|------------|
| | | vc (m/min) | f (mm/rev) | ap (mm) | vc (m/min) | f (mm/rev) | ap (mm) | vc (m/min) | f (mm/rev) | ap (mm) | vc (m/min) | f (mm/rev) | ap (mm) | vc (m/min) | f (mm/rev) | ap (mm) | vc (m/min) | f (mm/rev) | ap (mm) |

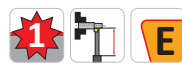
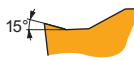
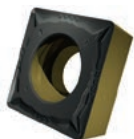



FM geometria per operazioni da finitura fino a semi sgrossatura, da taglio continuo a leggermente interrotto.

| | | | | | | | | | | | | | | | | | | | | |
|-----------------|-------|-----|-----|------|-----|---|---|---|-----|------|-----|---|---|---|---|---|---|---|---|---|
| SCMT 09T304E-FM | T9415 | 0.4 | 320 | 0.15 | 1.2 | - | - | - | 300 | 0.15 | 1.2 | - | - | - | - | - | - | - | - | - |
| SCMT 09T308E-FM | T9415 | 0.8 | 350 | 0.20 | 1.2 | - | - | - | 330 | 0.20 | 1.2 | - | - | - | - | - | - | - | - | - |
| SCMT 120404E-FM | T9415 | 0.4 | 315 | 0.15 | 1.6 | - | - | - | 295 | 0.15 | 1.6 | - | - | - | - | - | - | - | - | - |
| SCMT 120408E-FM | T9415 | 0.8 | 340 | 0.20 | 1.6 | - | - | - | 320 | 0.20 | 1.6 | - | - | - | - | - | - | - | - | - |
| SCMT 120412E-FM | T9415 | 1.2 | 320 | 0.27 | 1.6 | - | - | - | 300 | 0.27 | 1.6 | - | - | - | - | - | - | - | - | - |

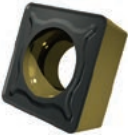
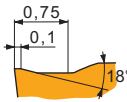

Idoneità e valori iniziali per velocità di taglio (Vc), avanzamento (f) e profondità di taglio (ap). Fare riferimento alla nostra App Machining Calculator per ulteriori calcoli.

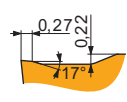
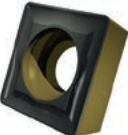
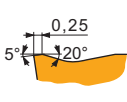
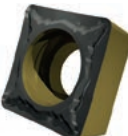
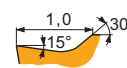
| Prodotto | RE (mm) | P | | | M | | | K | | | N | | | S | | | H | | |
|---|---|---------------|---------------|------------|---------------|---------------|------------|---------------|---------------|------------|---------------|---------------|------------|---------------|---------------|------------|---------------|---------------|------------|
| | | vc (m/min) | f (mm/rev) | ap (mm) | vc (m/min) | f (mm/rev) | ap (mm) | vc (m/min) | f (mm/rev) | ap (mm) | vc (m/min) | f (mm/rev) | ap (mm) | vc (m/min) | f (mm/rev) | ap (mm) | vc (m/min) | f (mm/rev) | ap (mm) |
|  |  | | | | | | | | | | | | | | | | | | |
| SCMT 09T308E-FM2 | T9415 0.8 | 340 | 0.17 | 1.0 | - | - | - | 320 | 0.17 | 1.0 | - | - | - | - | - | - | - | - | - |
|  |  | | | | | | | | | | | | | | | | | | |
| SCMT 09T308E-RM | T9415 0.8 | 295 | 0.30 | 2.0 | - | - | - | 280 | 0.30 | 2.0 | - | - | - | - | - | - | 55 | 0.15 | 0.7 |
| SCMT 120408E-RM | T9415 0.8 | 295 | 0.30 | 2.3 | - | - | - | 280 | 0.30 | 2.3 | - | - | - | - | - | - | 55 | 0.15 | 0.7 |
|  |  | | | | | | | | | | | | | | | | | | |
| SCMT 120408E-RM3 | T9415 0.8 | 265 | 0.27 | 2.3 | - | - | - | 250 | 0.27 | 2.3 | - | - | - | - | - | - | 50 | 0.14 | 0.7 |
|  |  | | | | | | | | | | | | | | | | | | |
| SCMT 09T304E-UR | T9415 0.4 | 280 | 0.15 | 1.2 | - | - | - | 265 | 0.15 | 1.2 | - | - | - | - | - | - | - | - | - |
| SCMT 09T308E-UR | T9415 0.8 | 300 | 0.20 | 1.2 | - | - | - | 285 | 0.20 | 1.2 | - | - | - | - | - | - | - | - | - |

SNMG



| | IC (mm) | D1 (mm) | L (mm) | S (mm) |
|------|------------|------------|-----------|-----------|
| 1204 | 12.700 | 5.16 | 12.70 | 4.76 |
| 1506 | 15.875 | 6.35 | 15.88 | 6.35 |
| 1906 | 19.050 | 7.94 | 19.05 | 6.35 |
| 2509 | 25.400 | 9.12 | 25.40 | 9.53 |

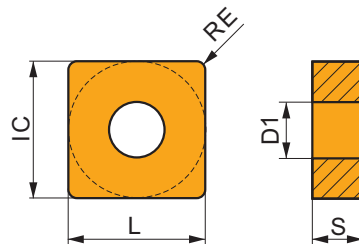

Idoneità e valori iniziali per velocità di taglio (Vc), avanzamento (f) e profondità di taglio (ap). Fare riferimento alla nostra App Machining Calculator per ulteriori calcoli.

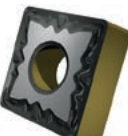
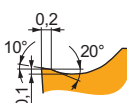
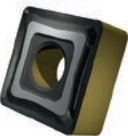
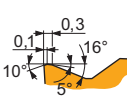
| Prodotto | RE (mm) | P | | | M | | | K | | | N | | | S | | | H | | |
|---|---|---------------|---------------|------------|---------------|---------------|------------|---------------|---------------|------------|---------------|---------------|------------|---------------|---------------|------------|---------------|---------------|------------|
| | | vc (m/min) | f (mm/rev) | ap (mm) | vc (m/min) | f (mm/rev) | ap (mm) | vc (m/min) | f (mm/rev) | ap (mm) | vc (m/min) | f (mm/rev) | ap (mm) | vc (m/min) | f (mm/rev) | ap (mm) | vc (m/min) | f (mm/rev) | ap (mm) |
|  |  | | | | | | | | | | | | | | | | | | |
| SNMG 120404E-FM | T9415 0.4 | 305 | 0.20 | 2.1 | - | - | - | 285 | 0.20 | 2.1 | - | - | - | - | - | - | - | - | - |
| SNMG 120408E-FM | T9415 0.8 | 365 | 0.20 | 2.1 | - | - | - | 345 | 0.20 | 2.1 | - | - | - | - | - | - | - | - | - |
| SNMG 120412E-FM | T9415 1.2 | 345 | 0.27 | 2.1 | - | - | - | 325 | 0.27 | 2.1 | - | - | - | - | - | - | - | - | - |
|  |  | | | | | | | | | | | | | | | | | | |
| SNMG 120408E-M | T9415 0.8 | 280 | 0.32 | 2.1 | - | - | - | 265 | 0.32 | 2.1 | - | - | - | - | - | - | 55 | 0.16 | 0.7 |
| SNMG 120412E-M | T9415 1.2 | 275 | 0.40 | 2.1 | - | - | - | 260 | 0.40 | 2.1 | - | - | - | - | - | - | 55 | 0.20 | 1.0 |



Idoneità e valori iniziali per velocità di taglio (Vc), avanzamento (f) e profondità di taglio (ap). Fare riferimento alla nostra App Machining Calculator per ulteriori calcoli.

| Prodotto | RE (mm) | P | | | M | | | K | | | N | | | S | | | H | | |
|----------|------------|---------------|---------------|------------|---------------|---------------|------------|---------------|---------------|------------|---------------|---------------|------------|---------------|---------------|------------|---------------|---------------|------------|
| | | vc (m/min) | f (mm/rev) | ap (mm) | vc (m/min) | f (mm/rev) | ap (mm) | vc (m/min) | f (mm/rev) | ap (mm) | vc (m/min) | f (mm/rev) | ap (mm) | vc (m/min) | f (mm/rev) | ap (mm) | vc (m/min) | f (mm/rev) | ap (mm) |

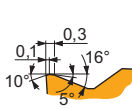
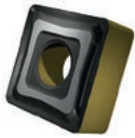

M geometria per operazioni da finitura fino a semi sgrossatura, da taglio continuo a interrotto.

| | | | | | | | | | | | | | | | | | | | | |
|----------------|-------|-----|-----|------|-----|---|---|---|-----|------|-----|---|---|---|---|---|---|----|------|-----|
| SNMG 150612E-M | T9415 | 1.2 | 260 | 0.40 | 3.4 | — | — | — | 245 | 0.40 | 3.4 | — | — | — | — | — | — | 50 | 0.20 | 1.0 |
| SNMG 190612E-M | T9415 | 1.2 | 255 | 0.40 | 4.0 | — | — | — | 240 | 0.40 | 4.0 | — | — | — | — | — | — | 50 | 0.20 | 1.0 |
| SNMG 190616E-M | T9415 | 1.6 | 270 | 0.40 | 4.0 | — | — | — | 255 | 0.40 | 4.0 | — | — | — | — | — | — | 50 | 0.20 | 1.3 |

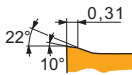

NMR geometria con design positivo per operazioni da media fino a sgrossatura, taglio continuo.

| | | | | | | | | | | | | | | | | | | | |
|------------------|-------|-----|-----|------|-----|----|------|-----|---|---|---|---|---|----|------|-----|---|---|---|
| SNMG 150612E-NMR | T8430 | 1.2 | 155 | 0.40 | 3.8 | 85 | 0.36 | 3.8 | — | — | — | — | — | 30 | 0.28 | 3.0 | — | — | — |
| SNMG 190616E-NMR | T8430 | 1.6 | 150 | 0.45 | 5.2 | 80 | 0.41 | 5.2 | — | — | — | — | — | 30 | 0.32 | 4.2 | — | — | — |
| | T9415 | 1.6 | 250 | 0.45 | 5.2 | — | — | — | — | — | — | — | — | — | — | — | — | — | — |

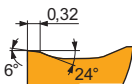
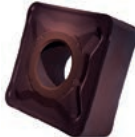

NRM geometria con design positivo per operazioni da semi sgrossatura fino a sgrossatura, da taglio continuo a moderatamente interrotto.

| | | | | | | | | | | | | | | | | | | | |
|-----------------|-------|-----|-----|------|-----|----|------|-----|-----|------|-----|---|---|----|------|-----|---|---|---|
| SNMG 120412-NRM | T8430 | 1.2 | 165 | 0.40 | 3.0 | 90 | 0.36 | 3.0 | — | — | — | — | — | 35 | 0.28 | 2.4 | — | — | — |
| | T9415 | 1.2 | 265 | 0.40 | 3.0 | — | — | — | — | — | — | — | — | — | — | — | — | — | — |
| SNMG 150616-NRM | T8430 | 1.6 | 150 | 0.45 | 5.0 | 80 | 0.41 | 5.0 | — | — | — | — | — | 30 | 0.32 | 4.0 | — | — | — |
| | T9415 | 1.6 | 250 | 0.45 | 5.0 | — | — | — | — | — | — | — | — | — | — | — | — | — | — |
| SNMG 250924-NRM | T9415 | 2.4 | 125 | 0.70 | 9.0 | — | — | — | 115 | 0.70 | 9.0 | — | — | — | — | — | — | — | — |

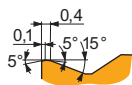
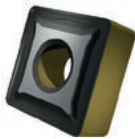

R geometria per operazioni da semi sgrossatura fino a sgrossatura, da taglio continuo a interrotto.

| | | | | | | | | | | | | | | | | | | | |
|----------------|-------|-----|-----|------|-----|---|---|---|-----|------|-----|---|---|---|---|---|----|------|-----|
| SNMG 120416E-R | T9415 | 1.6 | 250 | 0.50 | 3.8 | — | — | — | 235 | 0.50 | 3.8 | — | — | — | — | — | 50 | 0.25 | 1.3 |
| SNMG 150612E-R | T9415 | 1.2 | 245 | 0.45 | 4.5 | — | — | — | 230 | 0.45 | 4.5 | — | — | — | — | — | 45 | 0.23 | 1.0 |
| SNMG 190616E-R | T9415 | 1.6 | 240 | 0.50 | 6.0 | — | — | — | 225 | 0.50 | 6.0 | — | — | — | — | — | 45 | 0.25 | 1.3 |

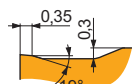
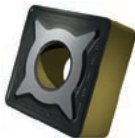

RM geometria per operazioni da semi sgrossatura fino a sgrossatura, da taglio continuo a interrotto.

| | | | | | | | | | | | | | | | | | | | |
|-----------------|-------|-----|-----|------|------|----|------|-----|-----|------|------|---|---|----|------|-----|---|---|---|
| SNMG 120408E-RM | T9415 | 0.8 | 280 | 0.40 | 4.0 | — | — | — | 265 | 0.40 | 4.0 | — | — | — | — | — | — | — | — |
| SNMG 120412E-RM | T9415 | 1.2 | 280 | 0.45 | 4.0 | — | — | — | 265 | 0.45 | 4.0 | — | — | — | — | — | — | — | — |
| SNMG 120416E-RM | T9415 | 1.6 | 290 | 0.50 | 4.0 | — | — | — | 275 | 0.50 | 4.0 | — | — | — | — | — | — | — | — |
| SNMG 150612E-RM | T9415 | 1.2 | 275 | 0.45 | 5.0 | — | — | — | 260 | 0.45 | 5.0 | — | — | — | — | — | — | — | — |
| SNMG 150616E-RM | T9415 | 1.6 | 285 | 0.50 | 5.0 | — | — | — | 270 | 0.50 | 5.0 | — | — | — | — | — | — | — | — |
| SNMG 190612E-RM | T9415 | 1.2 | 270 | 0.45 | 7.0 | — | — | — | 255 | 0.45 | 7.0 | — | — | — | — | — | — | — | — |
| SNMG 190616E-RM | T8430 | 1.6 | 165 | 0.50 | 7.0 | 90 | 0.45 | 7.0 | 135 | 0.50 | 7.0 | — | — | 35 | 0.35 | 5.6 | — | — | — |
| | T9415 | 1.6 | 270 | 0.50 | 7.0 | — | — | — | 255 | 0.50 | 7.0 | — | — | — | — | — | — | — | — |
| SNMG 250924E-RM | T9415 | 2.4 | 130 | 0.80 | 12.0 | — | — | — | 120 | 0.80 | 12.0 | — | — | — | — | — | — | — | — |

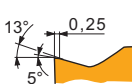
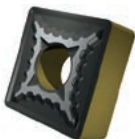

SM geometria con design positivo per medie lavorazioni, da taglio continuo a interrotto.

| | | | | | | | | | | | | | | | | | | | |
|-----------------|-------|-----|-----|------|-----|---|---|---|-----|------|-----|---|---|---|---|---|----|------|-----|
| SNMG 120408E-SM | T9415 | 0.8 | 325 | 0.25 | 1.8 | — | — | — | 305 | 0.25 | 1.8 | — | — | — | — | — | 65 | 0.13 | 0.7 |
| SNMG 120412E-SM | T9415 | 1.2 | 325 | 0.30 | 1.8 | — | — | — | 305 | 0.30 | 1.8 | — | — | — | — | — | 65 | 0.15 | 1.0 |



SNMM

| | IC (mm) | D1 (mm) | L (mm) | S (mm) |
|------|------------|------------|-----------|-----------|
| 1204 | 12.700 | 5.16 | 12.70 | 4.76 |
| 1506 | 15.875 | 6.35 | 15.88 | 6.35 |
| 1906 | 19.050 | 7.94 | 19.05 | 6.35 |
| 2507 | 25.400 | 9.12 | 25.40 | 7.94 |
| 2509 | 25.400 | 9.12 | 25.40 | 9.53 |

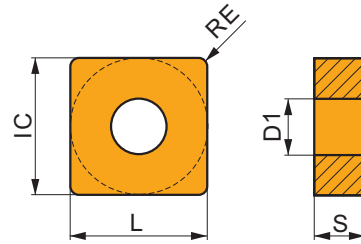

Idoneità e valori iniziali per velocità di taglio (Vc), avanzamento (f) e profondità di taglio (ap). Fare riferimento alla nostra App Machining Calculator per ulteriori calcoli.

| Prodotto | RE (mm) | P | | | M | | | K | | | N | | | S | | | H | | |
|----------|------------|---------------|---------------|------------|---------------|---------------|------------|---------------|---------------|------------|---------------|---------------|------------|---------------|---------------|------------|---------------|---------------|------------|
| | | vc (m/min) | f (mm/rev) | ap (mm) | vc (m/min) | f (mm/rev) | ap (mm) | vc (m/min) | f (mm/rev) | ap (mm) | vc (m/min) | f (mm/rev) | ap (mm) | vc (m/min) | f (mm/rev) | ap (mm) | vc (m/min) | f (mm/rev) | ap (mm) |

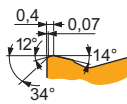
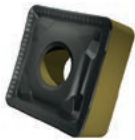

HR geometria per operazioni da sgrossatura fino a sgrossatura pesante, taglio continuo e interrotto.

| | | | | | | | | | | | | | | | | | | |
|-----------------|-------|-----|-----|------|------|---|---|---|-----|------|------|---|---|---|---|---|---|---|
| SNMM 190624E-HR | T9415 | 2.4 | 130 | 0.65 | 9.0 | – | – | – | 120 | 0.65 | 9.0 | – | – | – | – | – | – | – |
| SNMM 250724E-HR | T9415 | 2.4 | 125 | 0.65 | 13.0 | – | – | – | 115 | 0.65 | 13.0 | – | – | – | – | – | – | – |
| SNMM 250924E-HR | T9415 | 2.4 | 125 | 0.65 | 13.0 | – | – | – | 115 | 0.65 | 13.0 | – | – | – | – | – | – | – |

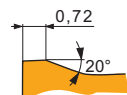
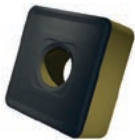

HR2 geometria per operazioni da sgrossatura fino a sgrossatura pesante, taglio continuo e interrotto.

| | | | | | | | | | | | | | | | | | | |
|------------------|-------|-----|-----|------|------|---|---|---|-----|------|------|---|---|---|---|---|---|---|
| SNMM 190616E-HR2 | T9415 | 1.6 | 125 | 0.65 | 8.9 | – | – | – | 115 | 0.65 | 8.9 | – | – | – | – | – | – | – |
| SNMM 190624E-HR2 | T9415 | 2.4 | 120 | 0.85 | 8.9 | – | – | – | 110 | 0.85 | 8.9 | – | – | – | – | – | – | – |
| SNMM 250924E-HR2 | T9415 | 2.4 | 115 | 0.85 | 11.0 | – | – | – | 105 | 0.85 | 11.0 | – | – | – | – | – | – | – |

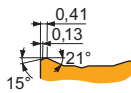
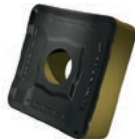

NR2 geometria per operazioni da semi sgrossatura fino a sgrossatura, da taglio continuo a interrotto.

| | | | | | | | | | | | | | | | | | | |
|------------------|-------|-----|-----|------|------|---|---|---|-----|------|------|---|---|---|---|---|---|---|
| SNMM 190616E-NR2 | T9415 | 1.6 | 260 | 0.50 | 8.0 | – | – | – | 245 | 0.50 | 8.0 | – | – | – | – | – | – | – |
| SNMM 250724E-NR2 | T9415 | 2.4 | 125 | 0.80 | 12.0 | – | – | – | 115 | 0.80 | 12.0 | – | – | – | – | – | – | – |
| SNMM 250924E-NR2 | T9415 | 2.4 | 125 | 0.80 | 12.0 | – | – | – | 115 | 0.80 | 12.0 | – | – | – | – | – | – | – |

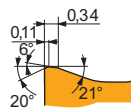
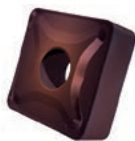

NRM geometria con design positivo per operazioni da semi sgrossatura fino a sgrossatura, da taglio continuo a moderatamente interrotto.

| | | | | | | | | | | | | | | | | | | |
|------------------|-------|-----|-----|------|-----|----|------|-----|-----|------|-----|---|---|---|----|------|-----|---|
| SNMM 250724E-NRM | T9415 | 2.4 | 130 | 0.65 | 9.0 | – | – | – | 120 | 0.65 | 9.0 | – | – | – | – | – | – | – |
| SNMM 250924E-NRM | T8430 | 2.4 | 130 | 0.70 | 9.0 | 70 | 0.63 | 9.0 | 105 | 0.70 | 9.0 | – | – | – | 25 | 0.49 | 7.2 | – |

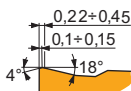
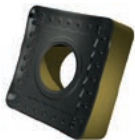

OR geometria per operazioni da semi sgrossatura fino a sgrossatura, da taglio continuo a interrotto.

| | | | | | | | | | | | | | | | | | | |
|-----------------|-------|-----|-----|------|------|---|---|---|-----|------|------|---|---|---|---|---|---|---|
| SNMM 120408E-OR | T9415 | 0.8 | 265 | 0.40 | 4.7 | – | – | – | 250 | 0.40 | 4.7 | – | – | – | – | – | – | – |
| SNMM 120412E-OR | T9415 | 1.2 | 270 | 0.45 | 4.7 | – | – | – | 255 | 0.45 | 4.7 | – | – | – | – | – | – | – |
| SNMM 150616E-OR | T9415 | 1.6 | 265 | 0.50 | 6.0 | – | – | – | 250 | 0.50 | 6.0 | – | – | – | – | – | – | – |
| SNMM 190612E-OR | T9415 | 1.2 | 250 | 0.45 | 8.0 | – | – | – | 235 | 0.45 | 8.0 | – | – | – | – | – | – | – |
| SNMM 190616E-OR | T9415 | 1.6 | 260 | 0.50 | 8.0 | – | – | – | 245 | 0.50 | 8.0 | – | – | – | – | – | – | – |
| SNMM 190624E-OR | T9415 | 2.4 | 225 | 0.80 | 8.0 | – | – | – | 210 | 0.80 | 8.0 | – | – | – | – | – | – | – |
| SNMM 250724E-OR | T9415 | 2.4 | 120 | 1.00 | 12.0 | – | – | – | 110 | 1.00 | 12.0 | – | – | – | – | – | – | – |
| SNMM 250924E-OR | T9415 | 2.4 | 120 | 1.00 | 12.0 | – | – | – | 110 | 1.00 | 12.0 | – | – | – | – | – | – | – |



Idoneità e valori iniziali per velocità di taglio (Vc), avanzamento (f) e profondità di taglio (ap). Fare riferimento alla nostra App Machining Calculator per ulteriori calcoli.

| Prodotto | RE (mm) | P | | | M | | | K | | | N | | | S | | | H | | |
|----------|------------|---------------|---------------|------------|---------------|---------------|------------|---------------|---------------|------------|---------------|---------------|------------|---------------|---------------|------------|---------------|---------------|------------|
| | | vc (m/min) | f (mm/rev) | ap (mm) | vc (m/min) | f (mm/rev) | ap (mm) | vc (m/min) | f (mm/rev) | ap (mm) | vc (m/min) | f (mm/rev) | ap (mm) | vc (m/min) | f (mm/rev) | ap (mm) | vc (m/min) | f (mm/rev) | ap (mm) |

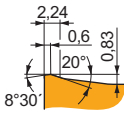

923 geometria per operazioni da semi sgrassatura fino a sgrassatura pesante, da taglio continuo a fortemente interrotto.

| | | | | | | | | | | | | | | | | | | |
|------------------|-------|-----|-----|------|------|---|---|---|-----|------|------|---|---|---|---|---|---|---|
| SNMM 250924S-923 | T9415 | 2.4 | 115 | 0.85 | 11.0 | - | - | - | 105 | 0.85 | 11.0 | - | - | - | - | - | - | - |
|------------------|-------|-----|-----|------|------|---|---|---|-----|------|------|---|---|---|---|---|---|---|

TCMT



| | IC (mm) | D1 (mm) | L (mm) | S (mm) |
|------|------------|------------|-----------|-----------|
| 06T1 | 3.970 | 2.20 | 6.90 | 1.98 |
| 0902 | 5.560 | 2.50 | 9.60 | 2.38 |
| 1102 | 6.350 | 2.80 | 11.00 | 2.38 |
| 16T3 | 9.525 | 4.40 | 16.50 | 3.97 |

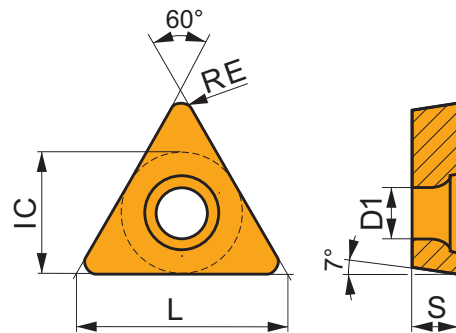

Idoneità e valori iniziali per velocità di taglio (Vc), avanzamento (f) e profondità di taglio (ap). Fare riferimento alla nostra App Machining Calculator per ulteriori calcoli.

| Prodotto | RE (mm) | P | | | M | | | K | | | N | | | S | | | H | | |
|----------|------------|---------------|---------------|------------|---------------|---------------|------------|---------------|---------------|------------|---------------|---------------|------------|---------------|---------------|------------|---------------|---------------|------------|
| | | vc (m/min) | f (mm/rev) | ap (mm) | vc (m/min) | f (mm/rev) | ap (mm) | vc (m/min) | f (mm/rev) | ap (mm) | vc (m/min) | f (mm/rev) | ap (mm) | vc (m/min) | f (mm/rev) | ap (mm) | vc (m/min) | f (mm/rev) | ap (mm) |

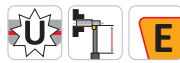
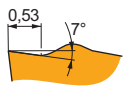

FF2 geometria positiva per operazioni da super finitura fino a finitura, da taglio continuo a leggermente interrotto.

| | | | | | | | | | | | | | | | | | |
|------------------|-------|-----|-----|------|-----|---|---|---|-----|------|-----|---|---|---|---|---|---|
| TCMT 06T102E-FF2 | T9415 | 0.2 | 335 | 0.05 | 0.8 | - | - | - | 315 | 0.05 | 0.8 | - | - | - | - | - | - |
| TCMT 06T104E-FF2 | T9415 | 0.4 | 265 | 0.12 | 0.8 | - | - | - | 250 | 0.12 | 0.8 | - | - | - | - | - | - |
| TCMT 090204E-FF2 | T9415 | 0.4 | 260 | 0.12 | 1.0 | - | - | - | 245 | 0.12 | 1.0 | - | - | - | - | - | - |
| TCMT 110204E-FF2 | T9415 | 0.4 | 265 | 0.12 | 0.8 | - | - | - | 250 | 0.12 | 0.8 | - | - | - | - | - | - |
| TCMT 110208E-FF2 | T9415 | 0.8 | 280 | 0.17 | 0.8 | - | - | - | 265 | 0.17 | 0.8 | - | - | - | - | - | - |
| TCMT 16T304E-FF2 | T9415 | 0.4 | 265 | 0.12 | 0.8 | - | - | - | 250 | 0.12 | 0.8 | - | - | - | - | - | - |
| TCMT 16T308E-FF2 | T9415 | 0.8 | 280 | 0.17 | 0.8 | - | - | - | 265 | 0.17 | 0.8 | - | - | - | - | - | - |

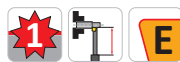

FM geometria per operazioni da finitura fino a semi sgrassatura, da taglio continuo a leggermente interrotto.

| | | | | | | | | | | | | | | | | | |
|-----------------|-------|-----|-----|------|-----|---|---|---|-----|------|-----|---|---|---|---|---|---|
| TCMT 110202E-FM | T9415 | 0.2 | 290 | 0.10 | 0.8 | - | - | - | 275 | 0.10 | 0.8 | - | - | - | - | - | - |
| TCMT 110204E-FM | T9415 | 0.4 | 295 | 0.12 | 0.8 | - | - | - | 280 | 0.12 | 0.8 | - | - | - | - | - | - |
| TCMT 110208E-FM | T9415 | 0.8 | 310 | 0.17 | 0.8 | - | - | - | 290 | 0.17 | 0.8 | - | - | - | - | - | - |
| TCMT 16T304E-FM | T9415 | 0.4 | 270 | 0.12 | 1.7 | - | - | - | 255 | 0.12 | 1.7 | - | - | - | - | - | - |
| TCMT 16T308E-FM | T9415 | 0.8 | 285 | 0.17 | 1.7 | - | - | - | 270 | 0.17 | 1.7 | - | - | - | - | - | - |

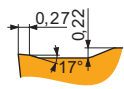

RM geometria per operazioni da semi sgrassatura fino a sgrassatura, da taglio continuo a interrotto.

| | | | | | | | | | | | | | | | | | | |
|-----------------|-------|-----|-----|------|-----|---|---|---|-----|------|-----|---|---|---|---|----|------|-----|
| TCMT 16T308E-RM | T9415 | 0.8 | 250 | 0.27 | 1.9 | - | - | - | 235 | 0.27 | 1.9 | - | - | - | - | 50 | 0.14 | 0.7 |
| TCMT 16T312E-RM | T9415 | 1.2 | 265 | 0.27 | 1.9 | - | - | - | 250 | 0.27 | 1.9 | - | - | - | - | 50 | 0.14 | 0.9 |

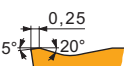

RM3 geometria per operazioni da semi sgrassatura fino a sgrassatura, da taglio continuo a interrotto.

| | | | | | | | | | | | | | | | | | | |
|------------------|-------|-----|-----|------|-----|---|---|---|-----|------|-----|---|---|---|---|----|------|-----|
| TCMT 16T304E-RM3 | T9415 | 0.4 | 205 | 0.20 | 2.0 | - | - | - | 190 | 0.20 | 2.0 | - | - | - | - | 40 | 0.14 | 0.3 |
|------------------|-------|-----|-----|------|-----|---|---|---|-----|------|-----|---|---|---|---|----|------|-----|



Idoneità e valori iniziali per velocità di taglio (Vc), avanzamento (f) e profondità di taglio (ap). Fare riferimento alla nostra App Machining Calculator per ulteriori calcoli.

| Prodotto | RE (mm) | P | | | M | | | K | | | N | | | S | | | H | | |
|----------|------------|---------------|---------------|------------|---------------|---------------|------------|---------------|---------------|------------|---------------|---------------|------------|---------------|---------------|------------|---------------|---------------|------------|
| | | vc (m/min) | f (mm/rev) | ap (mm) | vc (m/min) | f (mm/rev) | ap (mm) | vc (m/min) | f (mm/rev) | ap (mm) | vc (m/min) | f (mm/rev) | ap (mm) | vc (m/min) | f (mm/rev) | ap (mm) | vc (m/min) | f (mm/rev) | ap (mm) |

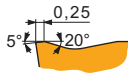

RM3 geometria per operazioni da semi sgrossatura fino a sgrossatura, da taglio continuo a interrotto.

| | | | | | | | | | | | | | | | | | | | | |
|------------------|-------|-----|-----|------|-----|---|---|---|-----|------|-----|---|---|---|---|---|---|----|------|-----|
| TCMT 16T308E-RM3 | T9415 | 0.8 | 220 | 0.27 | 2.0 | - | - | - | 205 | 0.27 | 2.0 | - | - | - | - | - | - | 40 | 0.14 | 0.7 |
|------------------|-------|-----|-----|------|-----|---|---|---|-----|------|-----|---|---|---|---|---|---|----|------|-----|

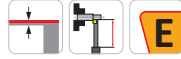
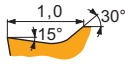

UR geometria per lavorazioni leggere e finitura, da taglio continuo a leggermente interrotto.

| | | | | | | | | | | | | | | | | | | | | |
|-----------------|-------|-----|-----|------|-----|---|---|---|-----|------|-----|---|---|---|---|---|---|---|---|---|
| TCMT 110204E-UR | T9415 | 0.4 | 255 | 0.12 | 0.8 | - | - | - | 240 | 0.12 | 0.8 | - | - | - | - | - | - | - | - | - |
| TCMT 16T304E-UR | T9415 | 0.4 | 255 | 0.12 | 0.8 | - | - | - | 240 | 0.12 | 0.8 | - | - | - | - | - | - | - | - | - |
| TCMT 16T308E-UR | T9415 | 0.8 | 265 | 0.17 | 0.8 | - | - | - | 250 | 0.17 | 0.8 | - | - | - | - | - | - | - | - | - |

TNMG



| | IC (mm) | D1 (mm) | L (mm) | S (mm) |
|------|------------|------------|-----------|-----------|
| 1604 | 9.525 | 3.81 | 16.50 | 4.76 |
| 2204 | 12.700 | 5.16 | 22.00 | 4.76 |
| 2706 | 15.875 | 6.35 | 27.50 | 6.35 |

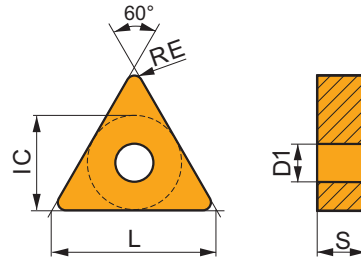

Idoneità e valori iniziali per velocità di taglio (Vc), avanzamento (f) e profondità di taglio (ap). Fare riferimento alla nostra App Machining Calculator per ulteriori calcoli.

| Prodotto | RE (mm) | P | | | M | | | K | | | N | | | S | | | H | | |
|----------|------------|---------------|---------------|------------|---------------|---------------|------------|---------------|---------------|------------|---------------|---------------|------------|---------------|---------------|------------|---------------|---------------|------------|
| | | vc (m/min) | f (mm/rev) | ap (mm) | vc (m/min) | f (mm/rev) | ap (mm) | vc (m/min) | f (mm/rev) | ap (mm) | vc (m/min) | f (mm/rev) | ap (mm) | vc (m/min) | f (mm/rev) | ap (mm) | vc (m/min) | f (mm/rev) | ap (mm) |

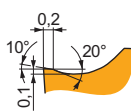
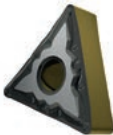

FM geometria positiva per operazioni da finitura fino a semi sgrossatura, da taglio continuo a leggermente interrotto.

| | | | | | | | | | | | | | | | | | | | | |
|-----------------|-------|-----|-----|------|-----|---|---|---|-----|------|-----|---|---|---|---|---|---|---|---|---|
| TNMG 160404E-FM | T9415 | 0.4 | 250 | 0.20 | 1.7 | - | - | - | 235 | 0.20 | 1.7 | - | - | - | - | - | - | - | - | - |
| TNMG 160408E-FM | T9415 | 0.8 | 300 | 0.20 | 1.7 | - | - | - | 285 | 0.20 | 1.7 | - | - | - | - | - | - | - | - | - |
| TNMG 160412E-FM | T9415 | 1.2 | 290 | 0.25 | 1.7 | - | - | - | 275 | 0.25 | 1.7 | - | - | - | - | - | - | - | - | - |
| TNMG 220404E-FM | T9415 | 0.4 | 250 | 0.20 | 1.7 | - | - | - | 235 | 0.20 | 1.7 | - | - | - | - | - | - | - | - | - |
| TNMG 220408E-FM | T9415 | 0.8 | 300 | 0.20 | 1.7 | - | - | - | 285 | 0.20 | 1.7 | - | - | - | - | - | - | - | - | - |

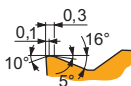
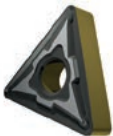

M geometria per operazioni da finitura fino a semi sgrossatura, da taglio continuo a interrotto.

| | | | | | | | | | | | | | | | | | | | | |
|----------------|-------|-----|-----|------|-----|---|---|---|-----|------|-----|---|---|---|---|---|---|----|------|-----|
| TNMG 160404E-M | T9415 | 0.4 | 230 | 0.20 | 1.6 | - | - | - | 215 | 0.20 | 1.6 | - | - | - | - | - | - | 45 | 0.14 | 0.3 |
| TNMG 160408E-M | T9415 | 0.8 | 240 | 0.30 | 1.6 | - | - | - | 225 | 0.30 | 1.6 | - | - | - | - | - | - | 45 | 0.15 | 0.7 |
| TNMG 160412E-M | T9415 | 1.2 | 225 | 0.40 | 1.6 | - | - | - | 210 | 0.40 | 1.6 | - | - | - | - | - | - | 45 | 0.20 | 0.9 |
| TNMG 220408E-M | T9415 | 0.8 | 230 | 0.30 | 2.1 | - | - | - | 215 | 0.30 | 2.1 | - | - | - | - | - | - | 45 | 0.15 | 0.7 |
| TNMG 220412E-M | T9415 | 1.2 | 225 | 0.40 | 2.1 | - | - | - | 210 | 0.40 | 2.1 | - | - | - | - | - | - | 45 | 0.20 | 0.9 |

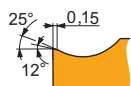
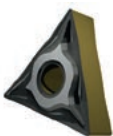

NF geometria con design altamente positivo per operazioni da finitura fino a medie lavorazioni, taglio continuo.

| | | | | | | | | | | | | | | | | | | | | |
|-----------------|-------|-----|-----|------|-----|---|---|---|-----|------|-----|---|---|---|---|---|---|---|---|---|
| TNMG 160404E-NF | T9415 | 0.4 | 285 | 0.15 | 1.4 | - | - | - | 270 | 0.15 | 1.4 | - | - | - | - | - | - | - | - | - |
|-----------------|-------|-----|-----|------|-----|---|---|---|-----|------|-----|---|---|---|---|---|---|---|---|---|



Idoneità e valori iniziali per velocità di taglio (Vc), avanzamento (f) e profondità di taglio (ap). Fare riferimento alla nostra App Machining Calculator per ulteriori calcoli.

| Prodotto | RE (mm) | P | | | M | | | K | | | N | | | S | | | H | | |
|----------|------------|---------------|---------------|------------|---------------|---------------|------------|---------------|---------------|------------|---------------|---------------|------------|---------------|---------------|------------|---------------|---------------|------------|
| | | vc (m/min) | f (mm/rev) | ap (mm) | vc (m/min) | f (mm/rev) | ap (mm) | vc (m/min) | f (mm/rev) | ap (mm) | vc (m/min) | f (mm/rev) | ap (mm) | vc (m/min) | f (mm/rev) | ap (mm) | vc (m/min) | f (mm/rev) | ap (mm) |

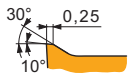
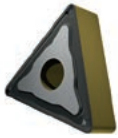

NM geometria con design altamente positivo per operazioni di finitura, media sgrassatura, taglio continuo.

| | | | | | | | | | | | | | | | | | | | |
|-----------------|-------|-----|-----|------|-----|---|---|---|---|---|---|---|---|---|---|---|---|---|---|
| TNMG 160408E-NM | T9415 | 0.8 | 290 | 0.25 | 1.9 | - | - | - | - | - | - | - | - | - | - | - | - | - | - |
|-----------------|-------|-----|-----|------|-----|---|---|---|---|---|---|---|---|---|---|---|---|---|---|

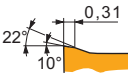

NMR geometria con design positivo per operazioni da media fino a sgrassatura, taglio continuo.

| | | | | | | | | | | | | | | | | | | | |
|------------------|-------|-----|-----|------|-----|----|------|-----|---|---|---|---|----|------|-----|---|---|---|---|
| TNMG 160408E-NMR | T9415 | 0.8 | 235 | 0.30 | 1.7 | - | - | - | - | - | - | - | - | - | - | - | - | - | - |
| TNMG 160412E-NMR | T8430 | 1.2 | 155 | 0.30 | 1.7 | 85 | 0.27 | 1.7 | - | - | - | - | 30 | 0.24 | 1.4 | - | - | - | - |
| | T9415 | 1.2 | 250 | 0.30 | 1.7 | - | - | - | - | - | - | - | - | - | - | - | - | - | - |
| TNMG 220412E-NMR | T9415 | 1.2 | 245 | 0.30 | 2.1 | - | - | - | - | - | - | - | - | - | - | - | - | - | - |

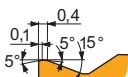
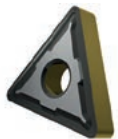

R geometria per operazioni da semi sgrassatura fino a sgrassatura, da taglio continuo a interrotto.

| | | | | | | | | | | | | | | | | | | | |
|----------------|-------|-----|-----|------|-----|---|---|---|-----|------|-----|---|---|---|---|---|----|------|-----|
| TNMG 160408E-R | T9415 | 0.8 | 205 | 0.40 | 3.0 | - | - | - | 190 | 0.40 | 3.0 | - | - | - | - | - | 40 | 0.20 | 0.7 |
| TNMG 160412E-R | T9415 | 1.2 | 215 | 0.40 | 3.0 | - | - | - | 200 | 0.40 | 3.0 | - | - | - | - | - | 40 | 0.20 | 0.9 |
| TNMG 220408E-R | T9415 | 0.8 | 195 | 0.40 | 4.0 | - | - | - | 185 | 0.40 | 4.0 | - | - | - | - | - | 35 | 0.20 | 0.7 |
| TNMG 220412E-R | T9415 | 1.2 | 205 | 0.40 | 4.0 | - | - | - | 190 | 0.40 | 4.0 | - | - | - | - | - | 40 | 0.20 | 0.9 |

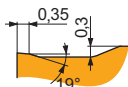
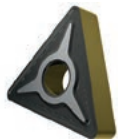

RM geometria per operazioni da semi sgrassatura fino a sgrassatura, da taglio continuo a interrotto.

| | | | | | | | | | | | | | | | | | | | |
|-----------------|-------|-----|-----|------|-----|---|---|---|-----|------|-----|---|---|---|---|---|---|---|---|
| TNMG 160408E-RM | T9415 | 0.8 | 235 | 0.40 | 3.0 | - | - | - | 220 | 0.40 | 3.0 | - | - | - | - | - | - | - | - |
| TNMG 160412E-RM | T9415 | 1.2 | 245 | 0.40 | 3.0 | - | - | - | 230 | 0.40 | 3.0 | - | - | - | - | - | - | - | - |
| TNMG 220408E-RM | T9415 | 0.8 | 225 | 0.40 | 4.0 | - | - | - | 210 | 0.40 | 4.0 | - | - | - | - | - | - | - | - |
| TNMG 220412E-RM | T9415 | 1.2 | 235 | 0.40 | 4.0 | - | - | - | 220 | 0.40 | 4.0 | - | - | - | - | - | - | - | - |
| TNMG 220416E-RM | T9415 | 1.6 | 250 | 0.40 | 4.0 | - | - | - | 235 | 0.40 | 4.0 | - | - | - | - | - | - | - | - |
| TNMG 270616E-RM | T9415 | 1.6 | 140 | 0.40 | 6.0 | - | - | - | 130 | 0.40 | 6.0 | - | - | - | - | - | - | - | - |

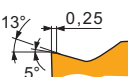
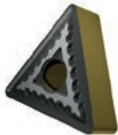

SM geometria con design positivo per medie lavorazioni, da taglio continuo a interrotto.

| | | | | | | | | | | | | | | | | | | | |
|-----------------|-------|-----|-----|------|-----|---|---|---|-----|------|-----|---|---|---|---|---|----|------|-----|
| TNMG 160404E-SM | T9415 | 0.4 | 240 | 0.20 | 1.7 | - | - | - | 225 | 0.20 | 1.7 | - | - | - | - | - | 45 | 0.14 | 0.3 |
| TNMG 160408E-SM | T9415 | 0.8 | 265 | 0.25 | 1.7 | - | - | - | 250 | 0.25 | 1.7 | - | - | - | - | - | 50 | 0.13 | 0.7 |
| TNMG 220408E-SM | T9415 | 0.8 | 265 | 0.25 | 1.7 | - | - | - | 250 | 0.25 | 1.7 | - | - | - | - | - | 50 | 0.13 | 0.7 |
| TNMG 220412E-SM | T9415 | 1.2 | 260 | 0.30 | 1.7 | - | - | - | 245 | 0.30 | 1.7 | - | - | - | - | - | 50 | 0.15 | 0.9 |



TNMM

| | IC (mm) | D1 (mm) | L (mm) | S (mm) |
|------|------------|------------|-----------|-----------|
| 1604 | 9.525 | 3.81 | 16.50 | 4.76 |

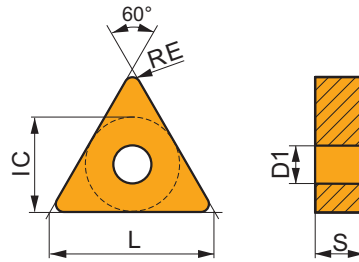

Idoneità e valori iniziali per velocità di taglio (Vc), avanzamento (f) e profondità di taglio (ap). Fare riferimento alla nostra App Machining Calculator per ulteriori calcoli.

| Prodotto | RE (mm) | P | | | M | | | K | | | N | | | S | | | H | | |
|----------|------------|---------------|---------------|------------|---------------|---------------|------------|---------------|---------------|------------|---------------|---------------|------------|---------------|---------------|------------|---------------|---------------|------------|
| | | vc (m/min) | f (mm/rev) | ap (mm) | vc (m/min) | f (mm/rev) | ap (mm) | vc (m/min) | f (mm/rev) | ap (mm) | vc (m/min) | f (mm/rev) | ap (mm) | vc (m/min) | f (mm/rev) | ap (mm) | vc (m/min) | f (mm/rev) | ap (mm) |

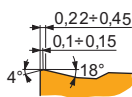
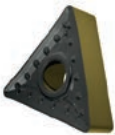

OR geometria per operazioni da semi sgrossatura fino a sgrossatura, da taglio continuo a interrotto.

| | | | | | | | | | | | | | | | | | | |
|-----------------|-------|-----|-----|------|-----|---|---|---|-----|------|-----|---|---|---|---|---|---|---|
| TNMM 160408E-OR | T9415 | 0.8 | 225 | 0.40 | 3.0 | — | — | — | 210 | 0.40 | 3.0 | — | — | — | — | — | — | — |
|-----------------|-------|-----|-----|------|-----|---|---|---|-----|------|-----|---|---|---|---|---|---|---|

VBMT

| | IC (mm) | D1 (mm) | L (mm) | S (mm) |
|------|------------|------------|-----------|-----------|
| 1103 | 6.350 | 2.80 | 11.10 | 3.18 |
| 1604 | 9.525 | 4.40 | 16.60 | 4.76 |

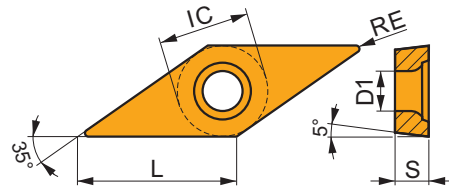

Idoneità e valori iniziali per velocità di taglio (Vc), avanzamento (f) e profondità di taglio (ap). Fare riferimento alla nostra App Machining Calculator per ulteriori calcoli.

| Prodotto | RE (mm) | P | | | M | | | K | | | N | | | S | | | H | | |
|----------|------------|---------------|---------------|------------|---------------|---------------|------------|---------------|---------------|------------|---------------|---------------|------------|---------------|---------------|------------|---------------|---------------|------------|
| | | vc (m/min) | f (mm/rev) | ap (mm) | vc (m/min) | f (mm/rev) | ap (mm) | vc (m/min) | f (mm/rev) | ap (mm) | vc (m/min) | f (mm/rev) | ap (mm) | vc (m/min) | f (mm/rev) | ap (mm) | vc (m/min) | f (mm/rev) | ap (mm) |

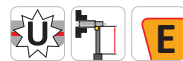
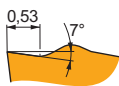

FF2 geometria positiva per operazioni da super finitura fino a finitura, da taglio continuo a leggermente interrotto.

| | | | | | | | | | | | | | | | | | |
|------------------|-------|-----|-----|------|-----|---|---|---|-----|------|-----|---|---|---|---|---|---|
| VBMT 160404E-FF2 | T9415 | 0.4 | 230 | 0.12 | 0.8 | — | — | — | 215 | 0.12 | 0.8 | — | — | — | — | — | — |
|------------------|-------|-----|-----|------|-----|---|---|---|-----|------|-----|---|---|---|---|---|---|

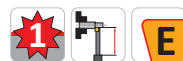

FM geometria per operazioni da finitura fino a semi sgrossatura, da taglio continuo a leggermente interrotto.

| | | | | | | | | | | | | | | | | | |
|-----------------|-------|-----|-----|------|-----|---|---|---|-----|------|-----|---|---|---|---|---|---|
| VBMT 110304E-FM | T9415 | 0.4 | 255 | 0.12 | 0.8 | — | — | — | 240 | 0.12 | 0.8 | — | — | — | — | — | — |
| VBMT 110308E-FM | T9415 | 0.8 | 270 | 0.17 | 0.8 | — | — | — | 255 | 0.17 | 0.8 | — | — | — | — | — | — |
| VBMT 160402E-FM | T9415 | 0.2 | 245 | 0.10 | 1.2 | — | — | — | 230 | 0.10 | 1.2 | — | — | — | — | — | — |
| VBMT 160404E-FM | T9415 | 0.4 | 245 | 0.12 | 1.2 | — | — | — | 230 | 0.12 | 1.2 | — | — | — | — | — | — |
| VBMT 160408E-FM | T9415 | 0.8 | 260 | 0.17 | 1.2 | — | — | — | 245 | 0.17 | 1.2 | — | — | — | — | — | — |
| VBMT 160412E-FM | T9415 | 1.2 | 245 | 0.22 | 1.2 | — | — | — | 230 | 0.22 | 1.2 | — | — | — | — | — | — |



Idoneità e valori iniziali per velocità di taglio (Vc), avanzamento (f) e profondità di taglio (ap). Fare riferimento alla nostra App Machining Calculator per ulteriori calcoli.

| Prodotto | RE (mm) | P | | | M | | | K | | | N | | | S | | | H | | |
|----------|------------|---------------|---------------|------------|---------------|---------------|------------|---------------|---------------|------------|---------------|---------------|------------|---------------|---------------|------------|---------------|---------------|------------|
| | | vc (m/min) | f (mm/rev) | ap (mm) | vc (m/min) | f (mm/rev) | ap (mm) | vc (m/min) | f (mm/rev) | ap (mm) | vc (m/min) | f (mm/rev) | ap (mm) | vc (m/min) | f (mm/rev) | ap (mm) | vc (m/min) | f (mm/rev) | ap (mm) |

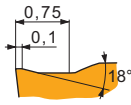

FM2 geometria per operazioni da finitura fino a lavorazioni medie, da taglio continuo a interrotto.

| | | | | | | | | | | | | | | | | | | | |
|------------------|-------|-----|-----|------|-----|---|---|---|-----|------|-----|---|---|---|---|---|---|---|---|
| VBMT 160404E-FM2 | T9415 | 0.4 | 220 | 0.12 | 1.2 | – | – | – | 205 | 0.12 | 1.2 | – | – | – | – | – | – | – | – |
| VBMT 160408E-FM2 | T9415 | 0.8 | 220 | 0.20 | 1.2 | – | – | – | 205 | 0.20 | 1.2 | – | – | – | – | – | – | – | – |
| VBMT 160412E-FM2 | T9415 | 1.2 | 225 | 0.22 | 1.2 | – | – | – | 210 | 0.22 | 1.2 | – | – | – | – | – | – | – | – |

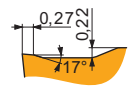

RM geometria per operazioni da semi sgrossatura fino a sgrossatura, da taglio continuo a interrotto.

| | | | | | | | | | | | | | | | | | | | |
|-----------------|-------|-----|-----|------|-----|---|---|---|-----|------|-----|---|---|---|---|---|----|------|-----|
| VBMT 160404E-RM | T9415 | 0.4 | 255 | 0.12 | 1.2 | – | – | – | 240 | 0.12 | 1.2 | – | – | – | – | – | 50 | 0.12 | 0.3 |
| VBMT 160408E-RM | T9415 | 0.8 | 270 | 0.17 | 1.2 | – | – | – | 255 | 0.17 | 1.2 | – | – | – | – | – | 50 | 0.12 | 0.7 |
| VBMT 160412E-RM | T9415 | 1.2 | 240 | 0.27 | 1.2 | – | – | – | 225 | 0.27 | 1.2 | – | – | – | – | – | 45 | 0.14 | 0.9 |

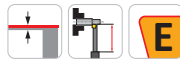
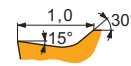

UR geometria per lavorazioni leggere e finitura, da taglio continuo a leggermente interrotto.

| | | | | | | | | | | | | | | | | | | | |
|-----------------|-------|-----|-----|------|-----|---|---|---|-----|------|-----|---|---|---|---|---|---|---|---|
| VBMT 160404E-UR | T9415 | 0.4 | 210 | 0.12 | 1.2 | – | – | – | 195 | 0.12 | 1.2 | – | – | – | – | – | – | – | – |
| VBMT 160408E-UR | T9415 | 0.8 | 225 | 0.17 | 1.2 | – | – | – | 210 | 0.17 | 1.2 | – | – | – | – | – | – | – | – |
| VBMT 160412E-UR | T9415 | 1.2 | 210 | 0.22 | 1.2 | – | – | – | 195 | 0.22 | 1.2 | – | – | – | – | – | – | – | – |

VCGT



| | IC (mm) | D1 (mm) | L (mm) | S (mm) |
|------|------------|------------|-----------|-----------|
| 1303 | 7.940 | 3.40 | 13.80 | 3.18 |

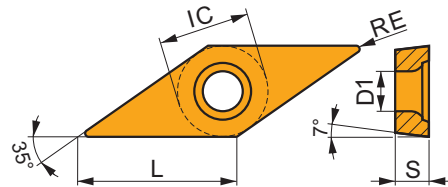

Idoneità e valori iniziali per velocità di taglio (Vc), avanzamento (f) e profondità di taglio (ap). Fare riferimento alla nostra App Machining Calculator per ulteriori calcoli.

| Prodotto | RE (mm) | P | | | M | | | K | | | N | | | S | | | H | | |
|----------|------------|---------------|---------------|------------|---------------|---------------|------------|---------------|---------------|------------|---------------|---------------|------------|---------------|---------------|------------|---------------|---------------|------------|
| | | vc (m/min) | f (mm/rev) | ap (mm) | vc (m/min) | f (mm/rev) | ap (mm) | vc (m/min) | f (mm/rev) | ap (mm) | vc (m/min) | f (mm/rev) | ap (mm) | vc (m/min) | f (mm/rev) | ap (mm) | vc (m/min) | f (mm/rev) | ap (mm) |

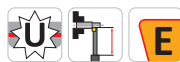
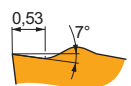

FF2 geometria positiva per operazioni da super finitura fino a finitura, da taglio continuo a leggermente interrotto.

| | | | | | | | | | | | | | | | | | | | |
|------------------|-------|-----|-----|------|-----|---|---|---|-----|------|-----|---|---|---|---|---|---|---|---|
| VCGT 130302E-FF2 | T9415 | 0.2 | 270 | 0.05 | 1.0 | – | – | – | 255 | 0.05 | 1.0 | – | – | – | – | – | – | – | – |
| VCGT 130304E-FF2 | T9415 | 0.4 | 215 | 0.12 | 1.0 | – | – | – | 200 | 0.12 | 1.0 | – | – | – | – | – | – | – | – |
| VCGT 130308E-FF2 | T9415 | 0.8 | 225 | 0.17 | 1.0 | – | – | – | 210 | 0.17 | 1.0 | – | – | – | – | – | – | – | – |



NF2 geometria con design positivo per operazioni da finitura e semi sgrossatura, taglio continuo.

| | | | | | | | | | | | | | | | | | | | |
|------------------|-------|-----|-----|------|-----|---|---|---|-----|------|-----|---|---|---|---|---|---|---|---|
| VCGT 130304E-NF2 | T9415 | 0.4 | 225 | 0.10 | 1.0 | – | – | – | 210 | 0.10 | 1.0 | – | – | – | – | – | – | – | – |
| VCGT 130308E-NF2 | T9415 | 0.8 | 225 | 0.17 | 1.0 | – | – | – | 210 | 0.17 | 1.0 | – | – | – | – | – | – | – | – |



VCMT

| | IC (mm) | D1 (mm) | L (mm) | S (mm) |
|------|------------|------------|-----------|-----------|
| 1103 | 6.350 | 2.80 | 11.10 | 3.18 |
| 1604 | 9.525 | 4.40 | 16.60 | 4.76 |

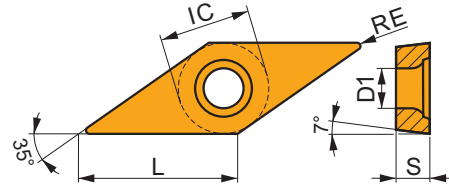

Idoneità e valori iniziali per velocità di taglio (Vc), avanzamento (f) e profondità di taglio (ap). Fare riferimento alla nostra App Machining Calculator per ulteriori calcoli.

| Prodotto | RE (mm) | P | | | M | | | K | | | N | | | S | | | H | | |
|----------|------------|---------------|---------------|------------|---------------|---------------|------------|---------------|---------------|------------|---------------|---------------|------------|---------------|---------------|------------|---------------|---------------|------------|
| | | vc (m/min) | f (mm/rev) | ap (mm) | vc (m/min) | f (mm/rev) | ap (mm) | vc (m/min) | f (mm/rev) | ap (mm) | vc (m/min) | f (mm/rev) | ap (mm) | vc (m/min) | f (mm/rev) | ap (mm) | vc (m/min) | f (mm/rev) | ap (mm) |

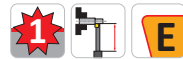
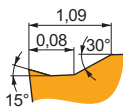

FM geometria per operazioni da finitura fino a semi sgrossatura, da taglio continuo a leggermente interrotto.

| | | | | | | | | | | | | | | | | | | | |
|-----------------|-------|-----|-----|------|-----|---|---|---|-----|------|-----|---|---|---|---|---|---|---|---|
| VCMT 160404E-FM | T9415 | 0.4 | 230 | 0.12 | 1.2 | — | — | — | 215 | 0.12 | 1.2 | — | — | — | — | — | — | — | — |
| VCMT 160408E-FM | T9415 | 0.8 | 245 | 0.17 | 1.2 | — | — | — | 230 | 0.17 | 1.2 | — | — | — | — | — | — | — | — |

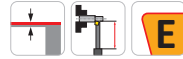
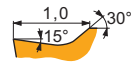

UR geometria per lavorazioni leggere e finitura, da taglio continuo a leggermente interrotto.

| | | | | | | | | | | | | | | | | | | | |
|-----------------|-------|-----|-----|------|-----|---|---|---|-----|------|-----|---|---|---|---|---|---|---|---|
| VCMT 110304E-UR | T9415 | 0.4 | 210 | 0.12 | 0.8 | — | — | — | 195 | 0.12 | 0.8 | — | — | — | — | — | — | — | — |
| VCMT 110308E-UR | T9415 | 0.8 | 220 | 0.17 | 0.8 | — | — | — | 205 | 0.17 | 0.8 | — | — | — | — | — | — | — | — |
| VCMT 160404E-UR | T9415 | 0.4 | 200 | 0.12 | 1.2 | — | — | — | 190 | 0.12 | 1.2 | — | — | — | — | — | — | — | — |
| VCMT 160408E-UR | T9415 | 0.8 | 210 | 0.17 | 1.2 | — | — | — | 195 | 0.17 | 1.2 | — | — | — | — | — | — | — | — |

VNMG

| | IC (mm) | D1 (mm) | L (mm) | S (mm) |
|------|------------|------------|-----------|-----------|
| 1604 | 9.525 | 3.81 | 16.60 | 4.76 |

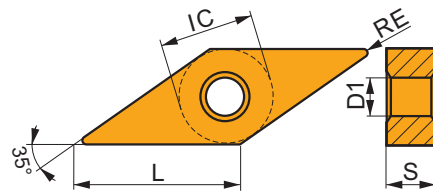

Idoneità e valori iniziali per velocità di taglio (Vc), avanzamento (f) e profondità di taglio (ap). Fare riferimento alla nostra App Machining Calculator per ulteriori calcoli.

| Prodotto | RE (mm) | P | | | M | | | K | | | N | | | S | | | H | | |
|----------|------------|---------------|---------------|------------|---------------|---------------|------------|---------------|---------------|------------|---------------|---------------|------------|---------------|---------------|------------|---------------|---------------|------------|
| | | vc (m/min) | f (mm/rev) | ap (mm) | vc (m/min) | f (mm/rev) | ap (mm) | vc (m/min) | f (mm/rev) | ap (mm) | vc (m/min) | f (mm/rev) | ap (mm) | vc (m/min) | f (mm/rev) | ap (mm) | vc (m/min) | f (mm/rev) | ap (mm) |

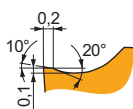







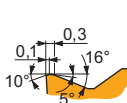

FM geometria positiva per operazioni da finitura fino a semi sgrossatura, da taglio continuo a leggermente interrotto.

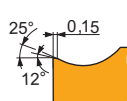
| | | | | | | | | | | | | | | | | | | | |
|-----------------|-------|-----|-----|------|-----|---|---|---|-----|------|-----|---|---|---|---|---|---|---|---|
| VNMG 160404E-FM | T9415 | 0.4 | 215 | 0.20 | 1.2 | — | — | — | 200 | 0.20 | 1.2 | — | — | — | — | — | — | — | — |
| VNMG 160408E-FM | T9415 | 0.8 | 255 | 0.20 | 1.4 | — | — | — | 240 | 0.20 | 1.4 | — | — | — | — | — | — | — | — |
| VNMG 160412E-FM | T9415 | 1.2 | 255 | 0.22 | 1.4 | — | — | — | 240 | 0.22 | 1.4 | — | — | — | — | — | — | — | — |

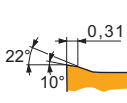

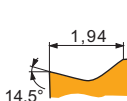
Idoneità e valori iniziali per velocità di taglio (Vc), avanzamento (f) e profondità di taglio (ap). Fare riferimento alla nostra App Machining Calculator per ulteriori calcoli.

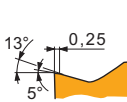
| Prodotto | RE (mm) | P | | | M | | | K | | | N | | | S | | | H | | | |
|---|---|---------------|---------------|------------|---------------|---------------|------------|---------------|---------------|------------|---------------|---------------|------------|---------------|---------------|------------|---------------|---------------|------------|-----|
| | | vc (m/min) | f (mm/rev) | ap (mm) | vc (m/min) | f (mm/rev) | ap (mm) | vc (m/min) | f (mm/rev) | ap (mm) | vc (m/min) | f (mm/rev) | ap (mm) | vc (m/min) | f (mm/rev) | ap (mm) | vc (m/min) | f (mm/rev) | ap (mm) | |
|  |  | | | | | | | | | | | | | | | | | | | |
| VNMG 160404E-M | T9415 | 0.4 | 195 | 0.20 | 1.2 | — | — | — | 185 | 0.20 | 1.2 | — | — | — | — | — | — | 35 | 0.14 | 0.3 |
| VNMG 160408E-M | T9415 | 0.8 | 200 | 0.30 | 1.4 | — | — | — | 190 | 0.30 | 1.4 | — | — | — | — | — | — | 40 | 0.15 | 0.7 |
|  |  | | | | | | | | | | | | | | | | | | | |
| VNMG 160404E-NF | T9415 | 0.4 | 255 | 0.12 | 1.2 | — | — | — | 240 | 0.12 | 1.2 | — | — | — | — | — | — | — | — | — |
| VNMG 160408E-NF | T9415 | 0.8 | 270 | 0.17 | 1.4 | — | — | — | 255 | 0.17 | 1.4 | — | — | — | — | — | — | — | — | — |
|  |  | | | | | | | | | | | | | | | | | | | |
| VNMG 160408E-NMR | T9415 | 0.8 | 200 | 0.30 | 1.4 | — | — | — | — | — | — | — | — | — | — | — | — | — | — | — |
|  |  | | | | | | | | | | | | | | | | | | | |
| VNMG 160408E-SF | T9415 | 0.8 | 255 | 0.17 | 1.4 | — | — | — | 240 | 0.17 | 1.4 | — | — | — | — | — | — | 50 | 0.12 | 0.7 |
|  |  | | | | | | | | | | | | | | | | | | | |
| VNMG 160404E-SM | T9415 | 0.4 | 210 | 0.18 | 1.2 | — | — | — | 195 | 0.18 | 1.2 | — | — | — | — | — | — | 40 | 0.13 | 0.3 |

WCMT



| | IC (mm) | D1 (mm) | L (mm) | S (mm) |
|------|------------|------------|-----------|-----------|
| 06T3 | 9.525 | 4.40 | 6.50 | 3.97 |
| 0804 | 12.700 | 5.50 | 8.70 | 4.76 |

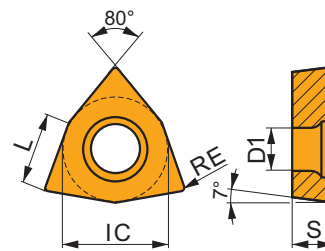

Idoneità e valori iniziali per velocità di taglio (Vc), avanzamento (f) e profondità di taglio (ap). Fare riferimento alla nostra App Machining Calculator per ulteriori calcoli.

| Prodotto | RE (mm) | P | | | M | | | K | | | N | | | S | | | H | | |
|--|---|---------------|---------------|------------|---------------|---------------|------------|---------------|---------------|------------|---------------|---------------|------------|---------------|---------------|------------|---------------|---------------|------------|
| | | vc (m/min) | f (mm/rev) | ap (mm) | vc (m/min) | f (mm/rev) | ap (mm) | vc (m/min) | f (mm/rev) | ap (mm) | vc (m/min) | f (mm/rev) | ap (mm) | vc (m/min) | f (mm/rev) | ap (mm) | vc (m/min) | f (mm/rev) | ap (mm) |
|  |  | | | | | | | | | | | | | | | | | | |
| WCMT 06T304E-FM | T9415 | 0.4 | 305 | 0.15 | 1.2 | — | — | — | 285 | 0.15 | 1.2 | — | — | — | — | — | — | — | — |
| WCMT 06T308E-FM | T9415 | 0.8 | 330 | 0.20 | 1.2 | — | — | — | 310 | 0.20 | 1.2 | — | — | — | — | — | — | — | — |
| WCMT 080408E-FM | T9415 | 0.8 | 315 | 0.20 | 1.7 | — | — | — | 295 | 0.20 | 1.7 | — | — | — | — | — | — | — | — |



WNMG

| | IC | D1 | L | S |
|------|--------|------|------|------|
| | (mm) | (mm) | (mm) | (mm) |
| 0604 | 9.525 | 3.81 | 6.50 | 4.76 |
| 0804 | 12.700 | 5.16 | 8.70 | 4.76 |

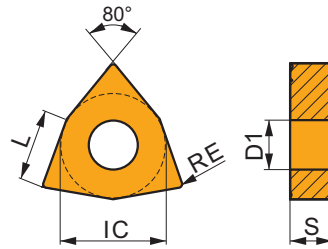

Idoneità e valori iniziali per velocità di taglio (Vc), avanzamento (f) e profondità di taglio (ap). Fare riferimento alla nostra App Machining Calculator per ulteriori calcoli.

| Prodotto | RE (mm) | P | | | M | | | K | | | N | | | S | | | H | | |
|----------|------------|---------------|---------------|------------|---------------|---------------|------------|---------------|---------------|------------|---------------|---------------|------------|---------------|---------------|------------|---------------|---------------|------------|
| | | vc (m/min) | f (mm/rev) | ap (mm) | vc (m/min) | f (mm/rev) | ap (mm) | vc (m/min) | f (mm/rev) | ap (mm) | vc (m/min) | f (mm/rev) | ap (mm) | vc (m/min) | f (mm/rev) | ap (mm) | vc (m/min) | f (mm/rev) | ap (mm) |

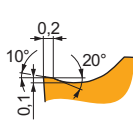
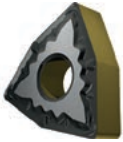

FM geometria positiva per operazioni da finitura fino a semi sgrassatura, da taglio continuo a leggermente interrotto.

| | | | | | | | | | | | | | | | | | | | |
|-----------------|-------|-----|-----|------|-----|---|---|---|-----|------|-----|---|---|---|---|---|---|---|---|
| WNMG 060404E-FM | T9415 | 0.4 | 305 | 0.20 | 1.4 | – | – | – | 285 | 0.20 | 1.4 | – | – | – | – | – | – | – | – |
| WNMG 060408E-FM | T9415 | 0.8 | 365 | 0.20 | 1.4 | – | – | – | 345 | 0.20 | 1.4 | – | – | – | – | – | – | – | – |
| WNMG 060412E-FM | T9415 | 1.2 | 350 | 0.27 | 1.2 | – | – | – | 330 | 0.27 | 1.2 | – | – | – | – | – | – | – | – |
| WNMG 080404E-FM | T9415 | 0.4 | 310 | 0.20 | 1.2 | – | – | – | 290 | 0.20 | 1.2 | – | – | – | – | – | – | – | – |
| WNMG 080408E-FM | T9415 | 0.8 | 350 | 0.20 | 1.9 | – | – | – | 330 | 0.20 | 1.9 | – | – | – | – | – | – | – | – |
| WNMG 080412E-FM | T9415 | 1.2 | 335 | 0.27 | 1.9 | – | – | – | 315 | 0.27 | 1.9 | – | – | – | – | – | – | – | – |

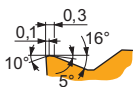
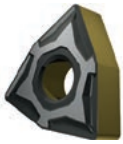

M geometria per operazioni da finitura fino a semi sgrassatura, da taglio continuo a interrotto.

| | | | | | | | | | | | | | | | | | | | |
|----------------|-------|-----|-----|------|-----|---|---|---|-----|------|-----|---|---|---|---|---|----|------|-----|
| WNMG 060404E-M | T9415 | 0.4 | 270 | 0.20 | 1.8 | – | – | – | 255 | 0.20 | 1.8 | – | – | – | – | – | 50 | 0.13 | 0.3 |
| WNMG 060408E-M | T9415 | 0.8 | 275 | 0.32 | 1.8 | – | – | – | 260 | 0.32 | 1.8 | – | – | – | – | – | 55 | 0.16 | 0.7 |
| WNMG 080404E-M | T9415 | 0.4 | 265 | 0.20 | 2.1 | – | – | – | 250 | 0.20 | 2.1 | – | – | – | – | – | 50 | 0.13 | 0.3 |
| WNMG 080408E-M | T9415 | 0.8 | 270 | 0.32 | 2.1 | – | – | – | 255 | 0.32 | 2.1 | – | – | – | – | – | 50 | 0.16 | 0.7 |
| WNMG 080412E-M | T9415 | 1.2 | 265 | 0.40 | 2.1 | – | – | – | 250 | 0.40 | 2.1 | – | – | – | – | – | 50 | 0.20 | 1.0 |

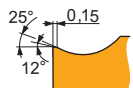
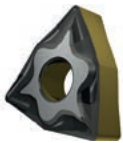

NF geometria con design altamente positivo per operazioni da finitura fino a medie lavorazioni, taglio continuo.

| | | | | | | | | | | | | | | | | | | | |
|-----------------|-------|-----|-----|------|-----|---|---|---|-----|------|-----|---|---|---|---|---|---|---|---|
| WNMG 060404E-NF | T9415 | 0.4 | 340 | 0.17 | 0.8 | – | – | – | 320 | 0.17 | 0.8 | – | – | – | – | – | – | – | – |
| WNMG 060408E-NF | T9415 | 0.8 | 380 | 0.19 | 1.0 | – | – | – | 360 | 0.19 | 1.0 | – | – | – | – | – | – | – | – |
| WNMG 080408E-NF | T9415 | 0.8 | 360 | 0.19 | 1.7 | – | – | – | 340 | 0.19 | 1.7 | – | – | – | – | – | – | – | – |
| WNMG 080412E-NF | T9415 | 1.2 | 315 | 0.30 | 2.1 | – | – | – | 295 | 0.30 | 2.1 | – | – | – | – | – | – | – | – |

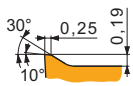
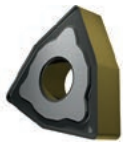

NM geometria con design altamente positivo per operazioni di finitura, media sgrassatura, taglio continuo.

| | | | | | | | | | | | | | | | | | | | |
|-----------------|-------|-----|-----|------|-----|---|---|---|---|---|---|---|---|---|---|---|---|---|---|
| WNMG 080404E-NM | T9415 | 0.4 | 305 | 0.20 | 2.1 | – | – | – | – | – | – | – | – | – | – | – | – | – | – |
| WNMG 080408E-NM | T9415 | 0.8 | 335 | 0.25 | 2.1 | – | – | – | – | – | – | – | – | – | – | – | – | – | – |

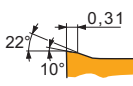









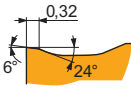

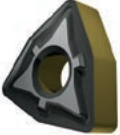
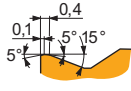

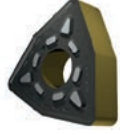
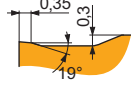

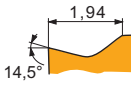

NMR geometria con design positivo per operazioni da media fino a sgrassatura, taglio continuo.

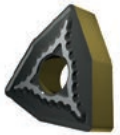
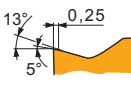
| | | | | | | | | | | | | | | | | | | | |
|------------------|-------|-----|-----|------|-----|----|------|-----|---|---|---|---|---|---|----|------|-----|---|---|
| WNMG 060408E-NMR | T8430 | 0.8 | 155 | 0.35 | 2.7 | 85 | 0.32 | 2.7 | – | – | – | – | – | – | 30 | 0.25 | 2.2 | – | – |
| WNMG 080404E-NMR | T9415 | 0.4 | 240 | 0.25 | 2.7 | – | – | – | – | – | – | – | – | – | – | – | – | – | – |
| WNMG 080408E-NMR | T9415 | 0.8 | 255 | 0.35 | 2.7 | – | – | – | – | – | – | – | – | – | – | – | – | – | – |
| WNMG 080412E-NMR | T9415 | 1.2 | 255 | 0.40 | 2.7 | – | – | – | – | – | – | – | – | – | – | – | – | – | – |

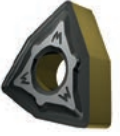
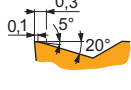

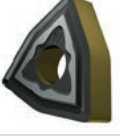
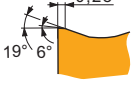
Idoneità e valori iniziali per velocità di taglio (Vc), avanzamento (f) e profondità di taglio (ap). Fare riferimento alla nostra App Machining Calculator per ulteriori calcoli.

| Prodotto | RE (mm) | P | | | M | | | K | | | N | | | S | | | H | | |
|--|---|---|---|---|---------------|---------------|------------|---------------|---------------|------------|---------------|---------------|------------|---------------|---------------|------------|---------------|---------------|------------|
| | | vc (m/min) | f (mm/rev) | ap (mm) | vc (m/min) | f (mm/rev) | ap (mm) | vc (m/min) | f (mm/rev) | ap (mm) | vc (m/min) | f (mm/rev) | ap (mm) | vc (m/min) | f (mm/rev) | ap (mm) | vc (m/min) | f (mm/rev) | ap (mm) |
|  |  |  |  | NRM geometria con design positivo per operazioni da semi sgrossatura fino a sgrossatura, da taglio continuo a moderatamente interrotto. | | | | | | | | | | | | | | | |
| WNMG 080408-NRM | T9415 0.8 | 255 | 0.35 | 2.7 | - | - | - | - | - | - | - | - | - | - | - | - | - | - | - |
| WNMG 080412-NRM | T8430 1.2 | 155 | 0.40 | 2.7 | 85 | 0.36 | 2.7 | - | - | - | - | - | 30 | 0.28 | 2.2 | - | - | - | - |
| | T9415 1.2 | 255 | 0.40 | 2.7 | - | - | - | - | - | - | - | - | - | - | - | - | - | - | - |
|  |  |  | R geometria per operazioni da semi sgrossatura fino a sgrossatura, da taglio continuo a interrotto. | | | | | | | | | | | | | | | | |
| WNMG 080408E-R | T9415 0.8 | 235 | 0.40 | 3.5 | - | - | - | 220 | 0.40 | 3.5 | - | - | - | - | - | 45 | 0.20 | 0.7 | - |
| WNMG 080412E-R | T9415 1.2 | 240 | 0.45 | 3.5 | - | - | - | 225 | 0.45 | 3.5 | - | - | - | - | - | 45 | 0.23 | 1.0 | - |
|  |  |  |  | RM geometria per operazioni da semi sgrossatura fino a sgrossatura, da taglio continuo a interrotto. | | | | | | | | | | | | | | | |
| WNMG 060412E-RM | T9415 1.2 | 280 | 0.45 | 3.0 | - | - | - | 265 | 0.45 | 3.0 | - | - | - | - | - | - | - | - | - |
| WNMG 080408E-RM | T9415 0.8 | 265 | 0.40 | 4.0 | - | - | - | 250 | 0.40 | 4.0 | - | - | - | - | - | - | - | - | - |
| WNMG 080412E-RM | T9415 1.2 | 270 | 0.45 | 4.0 | - | - | - | 255 | 0.45 | 4.0 | - | - | - | - | - | - | - | - | - |
| WNMG 080416E-RM | T9415 1.6 | 275 | 0.50 | 4.0 | - | - | - | 260 | 0.50 | 4.0 | - | - | - | - | - | - | - | - | - |
|  |  |  | SF geometria con design positivo per operazioni di finitura su pareti sottili, taglio continuo. | | | | | | | | | | | | | | | | |
| WNMG 080408E-SF | T9415 0.8 | 355 | 0.20 | 1.0 | - | - | - | 335 | 0.20 | 1.0 | - | - | - | - | - | 70 | 0.13 | 0.7 | - |
|  |  |  | SM geometria con design positivo per medie lavorazioni, da taglio continuo a interrotto. | | | | | | | | | | | | | | | | |
| WNMG 080404E-SM | T9415 0.4 | 280 | 0.20 | 2.0 | - | - | - | 265 | 0.20 | 2.0 | - | - | - | - | - | 55 | 0.13 | 0.3 | - |
| WNMG 080408E-SM | T9415 0.8 | 305 | 0.25 | 2.0 | - | - | - | 285 | 0.25 | 2.0 | - | - | - | - | - | 60 | 0.13 | 0.7 | - |
| WNMG 080412E-SM | T9415 1.2 | 300 | 0.30 | 2.0 | - | - | - | 285 | 0.30 | 2.0 | - | - | - | - | - | 60 | 0.15 | 1.0 | - |
|  |  |  |  | W-M geometria wiper per operazioni da semi sgrossatura fino a sgrossatura con maggiore velocità di avanzamento e finitura superficiale ottimizzata. | | | | | | | | | | | | | | | |
| WNMG 060408W-M | T9415 0.8 | 255 | 0.45 | 1.2 | - | - | - | 240 | 0.45 | 1.2 | - | - | - | - | - | - | - | - | - |
| WNMG 060412W-M | T9415 1.2 | 250 | 0.55 | 1.2 | - | - | - | 235 | 0.55 | 1.2 | - | - | - | - | - | - | - | - | - |
| WNMG 080408W-M | T9415 0.8 | 245 | 0.45 | 1.5 | - | - | - | 230 | 0.45 | 1.5 | - | - | - | - | - | - | - | - | - |
|  |  |  |  | W-MR geometria wiper per operazioni da finitura fino a sgrossatura con maggiore velocità di avanzamento e finitura superficiale ottimizzata. | | | | | | | | | | | | | | | |
| WNMG 060408W-MR | T9415 0.8 | 255 | 0.45 | 1.2 | - | - | - | 240 | 0.45 | 1.2 | - | - | - | - | - | - | - | - | - |
| WNMG 080404W-MR | T9415 0.4 | 240 | 0.30 | 1.5 | - | - | - | 225 | 0.30 | 1.5 | - | - | - | - | - | - | - | - | - |
| WNMG 080408W-MR | T9415 0.8 | 245 | 0.45 | 1.5 | - | - | - | 230 | 0.45 | 1.5 | - | - | - | - | - | - | - | - | - |
| WNMG 080412W-MR | T9415 1.2 | 245 | 0.55 | 1.5 | - | - | - | 230 | 0.55 | 1.5 | - | - | - | - | - | - | - | - | - |



DORMER PRAMET



AVETE GIÀ PROVATO IL NOSTRO NUOVO E-SHOP?

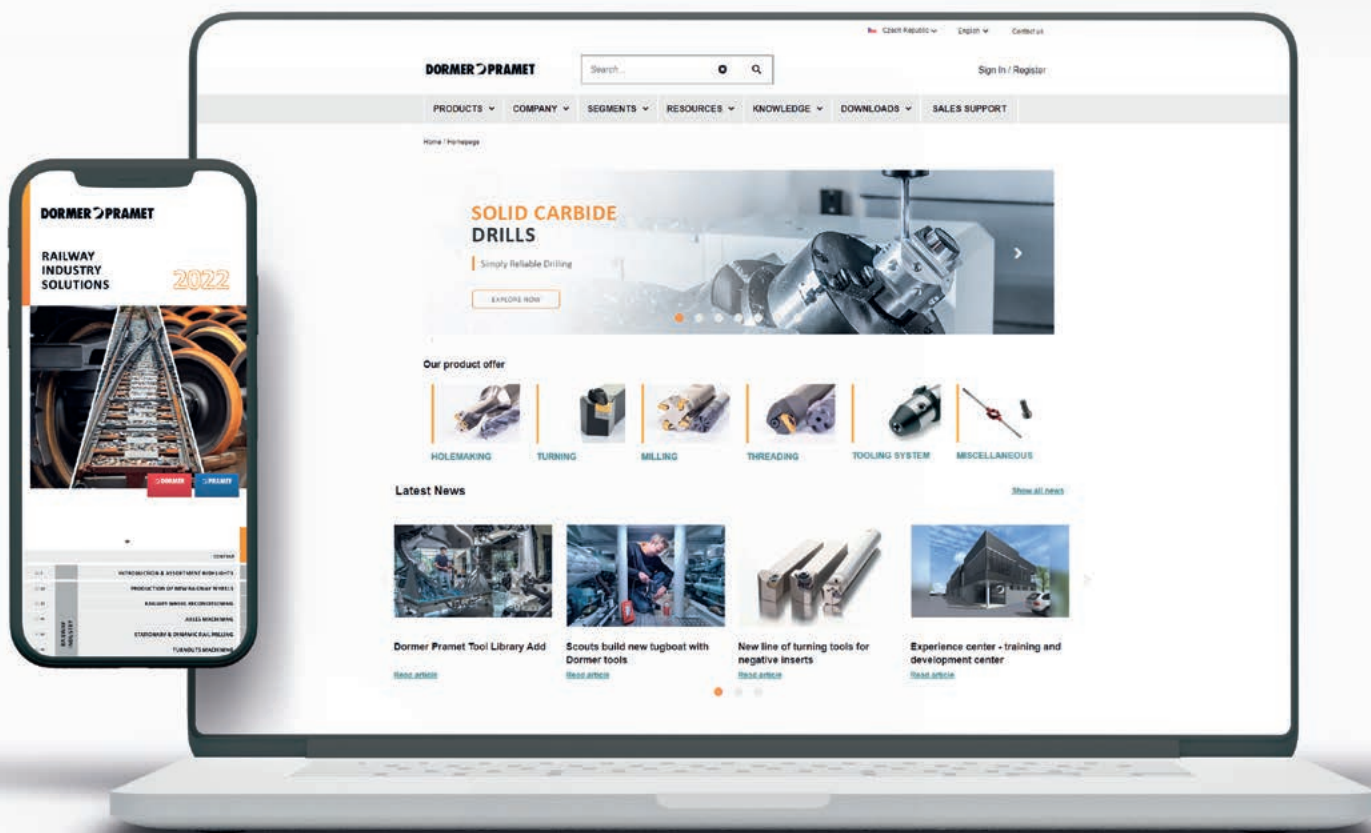



T8430

ROMPITRUCIOLI E RAGGI AGGIUNTIVI

INTRODUZIONE



Stiamo ampliando l'assortimento Pramet della nostra qualità di punta PVD T8430, la più versatile qualità per tornitura generale, sgrossatura pesante e condizioni sfavorevoli. Eccellente per acciaio, la qualità si comporta bene anche su acciaio inossidabile, ghisa e superleghe. L'estensione include inserti negativi con rompitruciolo NMR, NRM e RM, che ora sono disponibili con raggi inserto più grandi, aumentandone la gamma di applicazioni, le prestazioni e la durata nelle operazioni di sgrossatura.

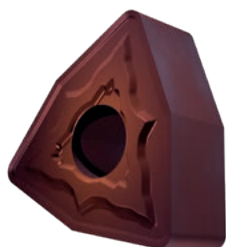

NMR

- Geometria versatile
- Acciaio tenero, acciaio inossidabile
- Taglio da leggero a medio

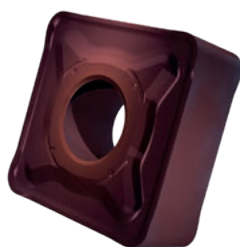

NRM

- Geometria per sgrossatura
- Acciaio tenero, acciaio inossidabile
- Taglio medio e sgrossatura

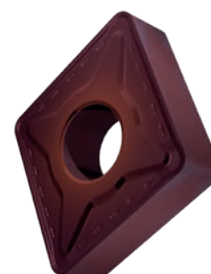

RM

- Geometria versatile
- Acciaio, acciaio inossidabile, ghisa
- Taglio da medio a sgrossatura



INSERTI DI TORNITURA NEGATIVI

CARATTERISTICHE E VANTAGGI

Rivestimento PVD multistrato.



VERSATILE

utilizzo per un'ampia gamma di operazioni.

L'esclusivo strato superiore in TiBN limita il tagliente di riporto a velocità di taglio basse.



VITA UTENSILE

notevolmente migliorata, soprattutto negli acciai.

Assortimento ampliato con raggi inserto più grandi, aumento della capacità di sgrossatura.



PRODUTTIVITÀ

aumentata grazie alla gamma di avanzamenti più ampia.

Geometrie NMR, NRM e RM con ampia fascetta a T positiva.



GAMMA DI APPLICAZIONE

estesa alla maggior parte dei materiali da lavorare.

Esclusivo strato superiore di Nitruro di Titanio – Boro (TiBN) per la riduzione del tagliente di riporto e per prestazioni migliori

Spesso rivestimento in TiN con basso stress da compressione per aumentare la resistenza alla craterizzazione

Strato duro in AlTiN per una maggior resistenza all'usura sul fianco

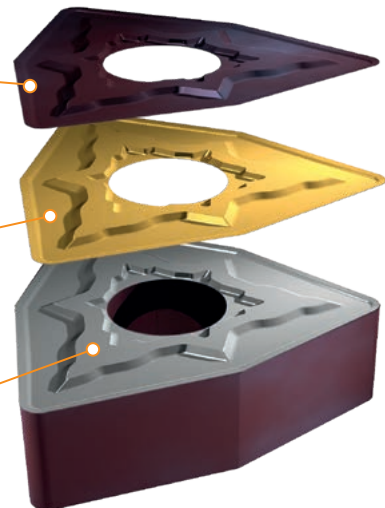

AREA APPLICATIVA DELLE QUALITÀ' PVD DI TORNITURA





KR

ESPANSIONE DI TORNITURA DELLA GHISA

INTRODUZIONE



La nostra famiglia di inserti per la tornitura di ghisa e materiali abrasivi è stata ampliata con nuove forme e raggi. Tutti gli inserti aggiunti di recente sono dotati di un robusto rompitruciolo KR con un'ampia fascetta T-land neutra e arrotondamento del tagliente, in combinazione con una qualità MT-CVD T5315 con rivestimento ad alto spessore.

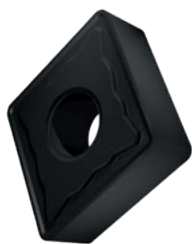

CNMG-KR

- Insetto produttivo
- Ghisa e acciaio duro
- Taglio medio e pesante



SNMG-KR

- Insetto da sgrossatura
- Ghisa e acciaio duro
- Taglio medio e pesante

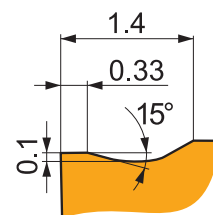

KR

- Progettato per la semi-sgrossatura e sgrossatura delle ghise, potenzialmente acciaio e materiali duri, taglio continuo e interrotto.



INSERTI DI TORNITURA NEGATIVI

CARATTERISTICHE E VANTAGGI

Robusta geometria KR con un'ampia fascetta T-land neutra e arrotondamento del tagliente.



AFFIDABILE E SICURO

processo di taglio nella tornitura di ghisa.

Disponibile nel grado MT-CVD T5315 con strati di rivestimento TiCN e Al₂O₃.



LUNGA DURATA DELL'UTENSILE

nella lavorazione dei materiali abrasivi.

Assortimento ampliato con raggi grandi, aumento della capacità di sgrossatura.



GAMMA DI APPLICAZIONE

ampliato per operazioni più pesanti.

Geometria stabile del tagliente

Rivestimento ad alto spessore MT-CVD

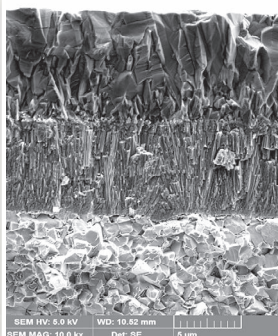

T5315

- Grado MT-CVD
- Strati TiCN e Al₂O₃
- Resistenza all'abrasione



DNMG-KR

- Inserto versatile
- Ghise, acciai duri
- Tagli da leggeri a pesanti

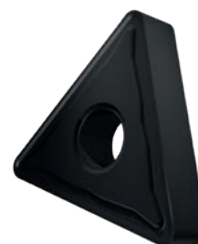

TNMG-KR

- Inserto sinterizzato di precisione
- Ghise, acciai duri
- Tagli da leggeri a medi



S-TYPE

UTENSILI DI TORNITURA PER MACCHINE A FANTINA MOBILE

INTRODUZIONE



Utensili metrici di tornitura esterna di piccole dimensioni dedicati per macchine a fantina mobile (o macchine di tipo svizzero) sono stati aggiunti alla gamma di tornitura Pramet. Tutti gli utensili hanno il sistema di bloccaggio ISO C lock per inserti piccoli CC, DC, TC, VB e VC. Questo li rende ideali per la lavorazione di piccoli pezzi. La larghezza funzionale di taglio è allineata al lato dello stelo (WF = B), quindi l'indicizzazione è ancora più precisa.



SCAC(RL)-S

- Utensili da esterni per inserti CC.. 09
- Dimensioni stelo 12 × 12, 16 × 16 mm
- KAPR 90°



SCLC(RL)-S

- Utensili da esterni per inserti CC.. 09
- Dimensioni stelo 12 × 12, 16 × 16 mm
- KAPR 95°



SDFC(RL)-S

- Utensili da esterni per inserti DC.. 07, 11
- Dimensioni stelo 12 × 12, 16 × 16 mm
- KAPR 91°



SDJC(RL)-S

- Utensili da esterni per inserti DC.. 07, 11
- Dimensioni stelo 12 × 12, 16 × 16 mm
- KAPR 93°



CARATTERISTICHE E VANTAGGI

Utensili appositamente progettati per le macchine a fantina mobile.



ELEVATO LIVELLO DI PRECISIONE

quando si cambiano gli utensili (dove $WF = B$).

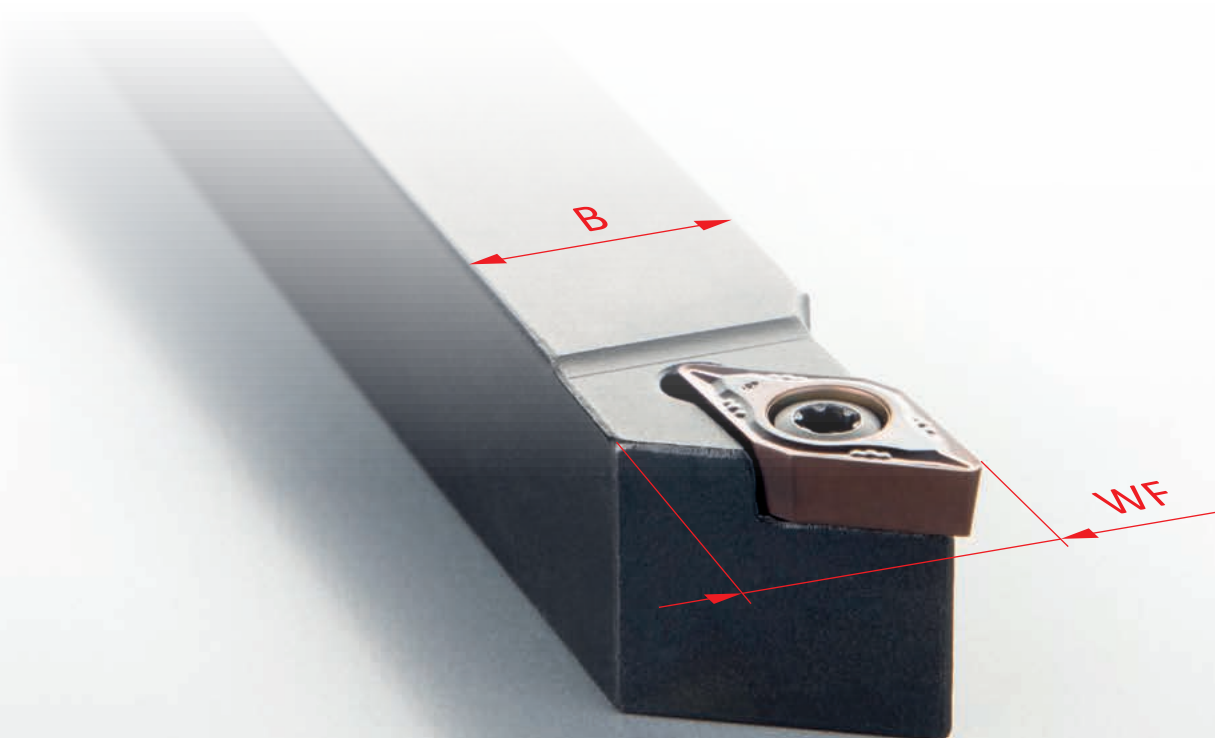

SDUCL-S

- Utensili da esterni per inserti DC.. 07
- Diametri del gambo 20 e 30 mm
- KAPR 93°



SDXC(RL)-S

- Utensili da esterni per inserti DC.. 07 , 11
- Dimensioni stelo 12 × 12, 16 × 16 mm
- KAPR 62.5°



STAC(RL)-S

- Utensili da esterni per inserti TC.. 11
- Dimensioni stelo 12 × 12, 16 × 16 mm
- KAPR 91°



SVJB(RL)-S

- Utensili da esterni per inserti VB.. 11 , VC.. 11
- Dimensioni stelo 12 × 12, 16 × 16 mm
- KAPR 93°



P & M

NUOVA LINEA DI UTENSILI PER INSERTI NEGATIVI

INTRODUZIONE



Stiamo introducendo una nuova linea di utensili per la tornitura esterna ed interna tipo P (stile con bloccaggio a leva) e tipo M (stile con bloccaggio superiore a staffa) con un nuovo design ed un nuovo trattamento superficiale. Tutti gli utensili sono ora nichelati per una maggiore resistenza all'usura ed all'ossidazione. Inoltre, tutte le barre di alesatura hanno canali per la lubrificazione interna per una maggiore durata dell'inserto ed una miglior evacuazione del truciolo. Nota importante: alcuni pezzi di ricambio, dimensioni o angoli di registrazione possono essere diversi rispetto agli utensili disponibili in precedenza.



P (EXT)

- Utensili da esterno con bloccaggio a leva



M (EXT)

- Utensili da esterno con bloccaggio a staffa



P (INT)

- Boreni con bloccaggio a leva



CARATTERISTICHE E VANTAGGI

Acciaio per utensili di alta qualità con nichelatura superficiale.



ELEVATA DURATA

e resistenza all'ossidazione.

Canali di lubrificazione interna in tutti gli utensili da interni.



DURATA INSERTO MIGLIORATA

grazie al calore ridotto sul tagliente.



Utensili nichelati per la protezione dall'ossidazione

Canali per la lubrificazione interna



SON06C

FRESA A SPIANARE PERFORMANTE A 16 TAGLIENTI

INTRODUZIONE



È stata lanciata una nuova famiglia di frese per spianatura altamente performante. L'ultima gamma Pramet include tre varianti di un inserto ONMX a 16 taglienti per profondità di taglio fino a 4 mm. Ciò include uno specifico inserto raschiante ONMX-W per una finitura superficiale di alta qualità con avanzamenti elevati e due varianti di inserti SNMX a 8 taglienti per sgrossatura con profondità di taglio fino a 7 mm. Sono disponibili diverse geometrie e frese per la lavorazione di un'ampia gamma di materiali.

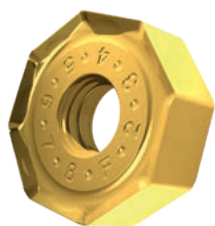

ONMX-F

- Inserti stampati performanti a 16 taglienti
- Acciaio, acciaio inossidabile e HRSA
- Applicazioni leggere



ONMX-M

- Inserti stampati performanti a 16 taglienti
- Acciaio, acciaio duro, inox e HRSA
- Applicazioni medie



ONMX-R

- Inserti stampati performanti a 16 taglienti
- Acciaio, acciaio duro e ghisa
- Applicazioni pesanti

CARATTERISTICHE E VANTAGGI DEGLI INSERTI

Inserti ottagonali negativi stampati.

▶ **16 TAGLIENTI**
per un maggiore risparmio sui costi.

Inserti ONMX geometrie F, M, R.

▶ **FACILE SCELTA**
geometria per taglio leggero, medio, pesante.

Ottima combinazione tra qualità e geometrie.

▶ **UTILIZZO VERSATILE**
su una ampia gamma di materiali.

Inserti quadrati negativi stampati.

▶ **8 TAGLIENTI**
inserto SNMX per profondità fino a 7 mm

Elevata profondità di taglio con inserti SNMX.

▶ **ELEVATO VOLUME DI TRUCIOLO**
con soluzione performante.

Disponibile geometria wiper su inserti ONMX-W.

▶ **ELEVATA QUALITA' SUPERFICIALE**
con grandi diametri fresa e avanzamenti elevati.

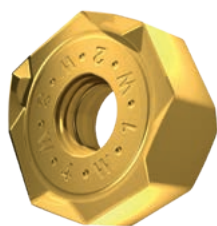
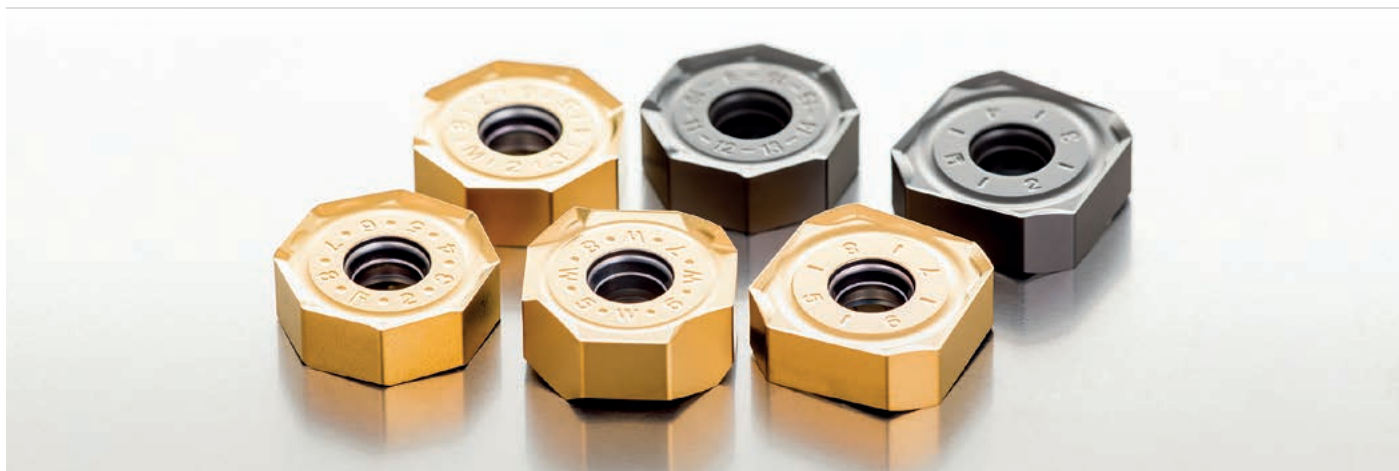

ONMX-W

- Inserto Wiper
- Acciaio, acciaio inossidabile
- Elevata qualità di finitura

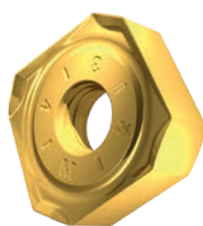

SNMX-M

- Inserto performante a 8 taglienti per sgrossatura
- Acciaio, acciaio duro, inox, HRSA
- Taglio medio

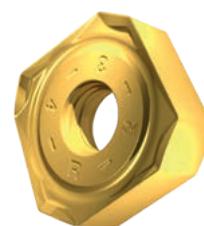

SNMX-R

- Inserto performante a 8 taglienti per sgrossatura
- Acciaio, ghisa e acciaio duro
- Taglio pesante



SON06C

FRESA A SPIANARE PERFORMANTE A 16 TAGLIENTI

FRESE SON06C – CARATTERISTICHE E VANTAGGI

Corpo fresa in acciaio di alta qualità nichelato.

▶ **GRANDE DURATA**
dei corpi fresa trattati.

Vite di bloccaggio robusta e facile montaggio sulla sede inserto indurita.

▶ **SEMPLICE E SICURO**
il bloccaggio inserti.

Fori per refrigerante interno su tutti i corpi fresa, inclusi grandi diametri.

▶ **VITA UTENSILE MIGLIORATA**
e miglior evacuazione trucioli, con elevata finitura superficiale ed affidabilità.

Corpi fresa a manicotto disponibili in un'ampia gamma di diametri e passi.

▶ **DIVERSE OPZIONI**
per un'ampia gamma di possibilità.



SON06C

- Fresa a manicotto
- Gamma diametri DC
50 – 250 mm
2.00 – 6.00 pollici



ESEMPI DI FRESATURA

Particolare: Piastra d'acciaio al Carbonio (210 HB)
 Materiale: 1.1191 / C45
 Fresa: 63A06R-S45ON06-C
 Refrigerante: Aria

| Dati di taglio | | | |
|---------------------------|------------|------------|--------------|
| v_c (m/min) | f_z (mm) | a_p (mm) | a_e (mm) |
| 250 | 0.25 | 2 | 50 |
| Geometria inserto in test | | | Durata (min) |
| ONMX 060508SR-M:M8330 | | | 42 |

ONMX 060508SR-M:M8330, 42 min

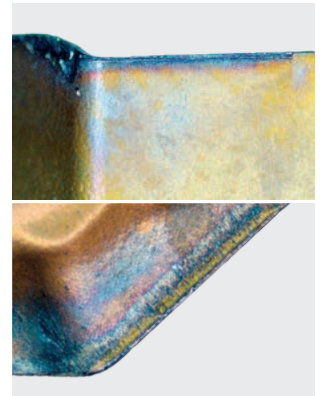

WMG P2.2

Particolare: Piastra in acciaio inox (145 HB)
 Materiale: 1.4404 / 316L
 Fresa: 63A06R-S45ON06-C
 Refrigerante: Aria

| Dati di taglio | | | |
|---------------------------|------------|------------|--------------|
| v_c (m/min) | f_z (mm) | a_p (mm) | a_e (mm) |
| 160 | 0.15 | 2 | 50 |
| Geometria inserto in test | | | Durata (min) |
| ONMX 060508SR-F:M6330 | | | 58 |

ONMX 060508SR-F:M6330, 58 min

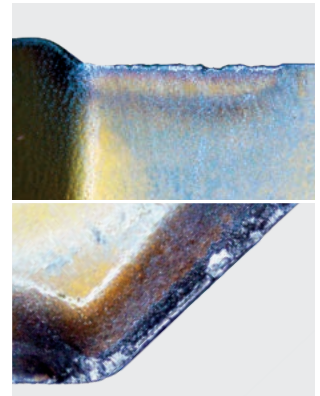

WMG M3.1

Particolare: Piastra in inox (145 HB)
 Materiale: 1.4404 / 316L
 Fresa: 63A06R-S45ON06-C
 Refrigerante: Emulsione al ~ 10%

| Dati di taglio | | | |
|---------------------------|------------|------------|--------------|
| v_c (m/min) | f_z (mm) | a_p (mm) | a_e (mm) |
| 80 | 0.15 | 2 | 50 |
| Geometria inserto in test | | | Durata (min) |
| ONMX 060508SR-F:M6330 | | | 56 |

ONMX 060508SR-F:M6330, 56 min

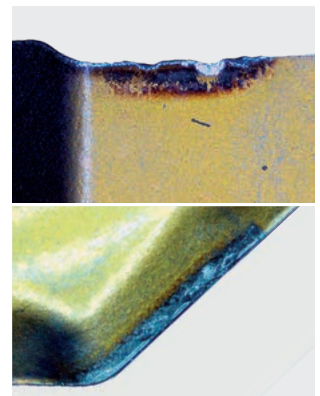

WMG M3.1

Particolare: Piastra in ghisa (205 HB)
 Materiale: GG25 / FC250
 Fresa: 63A06R-S45ON06-C
 Refrigerante: Aria

| Dati di taglio | | | |
|---------------------------|------------|------------|--------------|
| v_c (m/min) | f_z (mm) | a_p (mm) | a_e (mm) |
| 250 | 0.4 | 2 | 50 |
| Geometria inserto in test | | | Durata (min) |
| ONMX 060508SR-R:M5315 | | | 137+ |

ONMX 060508SR-R:M5315, 137 min

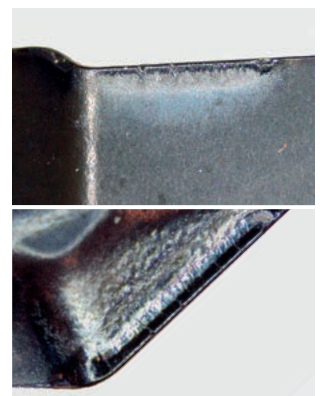

WMG K1.2



SON06C



PRAMET

S

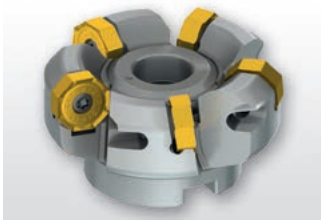

ECON ON06 Fresa per spianatura a 43° con geometria doppio negativa e passaggio refrigerante interno
 Fresa per operazioni di spianatura altamente produttiva prevede l'utilizzo di due tipologie di inserti negativi bilaterali. Inserti ottagonali economici ON..06 con 16 taglianti e APMX di 4 mm, e inserti quadrati ad alta produttività SN.. 17 inserti con 8 taglianti e APMX di 7 mm. Disponibilità di corpi fresa con passo differenziato dei denti. Corpo trattato per una maggiore vita utensile.

| | |
|------|-----------|
| KAPR | 43° |
| APMX | 4.0 (7.0) |

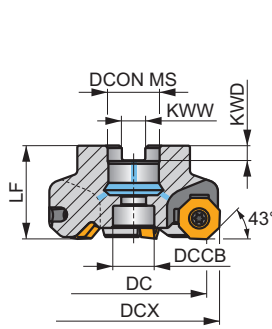
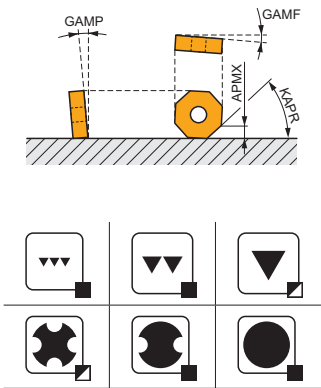

DC 50 – 125 mm

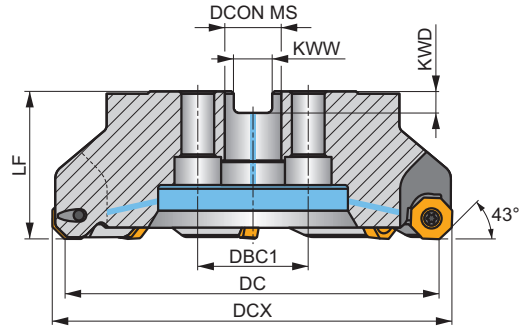

DC 160 – 250 mm

0.04 - 0.25

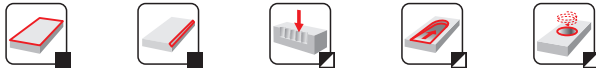

| Prodotto | DC | DCX | DCON MS | DCCB | DBC1 | LF | KWW | KWD | GAMF | GAMP | | | | | | | | |
|-------------------|------|-------|---------|------|-------|------|------|-------|------|------|----|---|------|----|-------|-------|-------|-------|
| | (mm) | (mm) | (mm) | (mm) | (mm) | (mm) | (mm) | (mm) | (°) | (°) | | | | kg | | | | |
| 50A04R-S450N06-C | 50 | 60.8 | 22 | 16.5 | - | 40 | 10.4 | 6.3 | -10 | -5 | 4 | ✓ | 9400 | ✓ | 0.42 | G1342 | C0621 | - |
| 50A05R-S450N06-C | 50 | 60.8 | 22 | 16.5 | - | 40 | 10.4 | 6.3 | -10 | -5 | 5 | - | 9400 | ✓ | 0.39 | G1342 | C0621 | - |
| 63A05R-S450N06-C | 63 | 73.8 | 22 | 18.1 | - | 40 | 10.4 | 6.3 | -10 | -5 | 5 | ✓ | 8400 | ✓ | 0.59 | G1342 | C0621 | - |
| 63A06R-S450N06-C | 63 | 73.8 | 22 | 18.1 | - | 40 | 10.4 | 6.3 | -10 | -5 | 6 | ✓ | 8400 | ✓ | 0.55 | G1342 | C0621 | - |
| 80A06R-S450N06-C | 80 | 90.8 | 27 | 22.1 | - | 50 | 12.4 | 7 | -10 | -5 | 6 | ✓ | 7500 | ✓ | 1.27 | G1342 | C0622 | - |
| 80A08R-S450N06-C | 80 | 90.8 | 27 | 22.1 | - | 50 | 12.4 | 7 | -10 | -5 | 8 | - | 7500 | ✓ | 1.19 | G1342 | C0622 | - |
| 100A08R-S450N06-C | 100 | 110.8 | 32 | 30.1 | - | 50 | 14.4 | 8 | -10 | -5 | 8 | ✓ | 6700 | ✓ | 1.88 | G1342 | C0620 | AC002 |
| 100A10R-S450N06-C | 100 | 110.8 | 32 | 30.1 | - | 50 | 14.4 | 8 | -10 | -5 | 10 | - | 6700 | ✓ | 1.81 | G1342 | C0620 | AC002 |
| 125A08R-S450N06-C | 125 | 135.8 | 40 | 56.1 | - | 63 | 16.4 | 9 | -10 | -5 | 8 | ✓ | 6000 | ✓ | 3.53 | G1342 | C0620 | AC003 |
| 125A10R-S450N06-C | 125 | 135.8 | 40 | 56.1 | - | 63 | 16.4 | 9 | -10 | -5 | 10 | ✓ | 6000 | ✓ | 3.65 | G1342 | C0620 | AC003 |
| 125A12R-S450N06-C | 125 | 135.8 | 40 | 56.1 | - | 63 | 16.4 | 9 | -11 | -5 | 12 | - | 6000 | ✓ | 3.55 | G1342 | C0620 | AC003 |
| 160C08R-S450N06-C | 160 | 170.8 | 40 | - | 66.7 | 63 | 16.4 | 9.25 | -10 | -5 | 8 | ✓ | 5700 | ✓ | 5.54 | G1342 | C0623 | - |
| 160C12R-S450N06-C | 160 | 170.8 | 40 | - | 66.7 | 63 | 16.4 | 9.25 | -10 | -5 | 12 | ✓ | 5700 | ✓ | 5.74 | G1342 | C0623 | - |
| 160C14R-S450N06-C | 160 | 170.8 | 40 | - | 66.7 | 63 | 16.4 | 9.25 | -11 | -5 | 14 | - | 5700 | ✓ | 5.65 | G1342 | C0623 | - |
| 200C12R-S450N06-C | 200 | 210.8 | 60 | - | 101.6 | 63 | 25.8 | 14.25 | -10 | -5 | 12 | ✓ | 4700 | ✓ | 9.00 | G1342 | C0624 | - |
| 200C16R-S450N06-C | 200 | 210.8 | 60 | - | 101.6 | 63 | 25.8 | 14.25 | -10 | -5 | 16 | - | 4700 | ✓ | 9.02 | G1342 | C0624 | - |
| 250C14R-S450N06-C | 250 | 260.8 | 60 | - | 101.6 | 63 | 25.8 | 14.25 | -10 | -5 | 14 | ✓ | 4300 | ✓ | 15.46 | G1342 | C0625 | - |
| 250C18R-S450N06-C | 250 | 260.8 | 60 | - | 101.6 | 63 | 25.8 | 14.25 | -10 | -5 | 18 | - | 4300 | ✓ | 15.51 | G1342 | C0625 | - |

| | | | |
|-------|-------------|-----------------|-------------|
| | | | |
| G1342 | ONMX 0605.. | ONMX 0605..-W.. | SNMX 1705.. |



| CO620 | US 45013A-T20P | 5.0 | M 5 | 13 | SDR T20P-T | - | - | - | - | - |
|-------|----------------|-----|-----|----|------------|----------|----------|-----------|-------|---|
| CO621 | US 45013A-T20P | 5.0 | M 5 | 13 | SDR T20P-T | HS 1030C | - | - | - | - |
| CO622 | US 45013A-T20P | 5.0 | M 5 | 13 | SDR T20P-T | HS 1230C | - | - | - | - |
| CO623 | US 45013A-T20P | 5.0 | M 5 | 13 | SDR T20P-T | HS 1240C | CAC 160C | HSD 0825C | HXK 5 | - |
| CO624 | US 45013A-T20P | 5.0 | M 5 | 13 | SDR T20P-T | HS 1655C | CAC 200C | HSD 1025C | HXK 7 | - |
| CO625 | US 45013A-T20P | 5.0 | M 5 | 13 | SDR T20P-T | HS 1655C | CAC 250C | HSD 1025C | HXK 7 | - |

| AC002 | | KS 1635 | K.FMH32 |
|-------|--|---------|---------|
| AC003 | | KS 2040 | K.FMH40 |

ONMX 06



| | IC (mm) | D1 (mm) | S (mm) |
|------|------------|------------|-----------|
| 0605 | 17.000 | 5.70 | 7.08 |

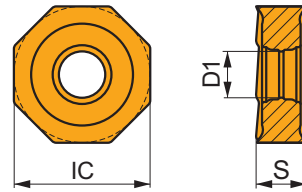

Idoneità e valori iniziali per velocità di taglio (Vc), avanzamento (f) e profondità di taglio (ap). Fare riferimento alla nostra App Machining Calculator per ulteriori calcoli.

| Prodotto | RE (mm) | P | | | M | | | K | | | N | | | S | | | H | | |
|----------|------------|---------------|-----------------|------------|---------------|-----------------|------------|---------------|-----------------|------------|---------------|-----------------|------------|---------------|-----------------|------------|---------------|-----------------|------------|
| | | vc (m/min) | f (mm/tooth) | ap (mm) | vc (m/min) | f (mm/tooth) | ap (mm) | vc (m/min) | f (mm/tooth) | ap (mm) | vc (m/min) | f (mm/tooth) | ap (mm) | vc (m/min) | f (mm/tooth) | ap (mm) | vc (m/min) | f (mm/tooth) | ap (mm) |

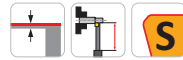
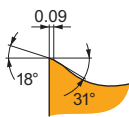
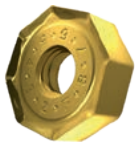

La geometria positiva F è utilizzata per la finitura, adatta per sbalzi elevati o per applicazioni caratterizzate da pareti e pezzi da lavorare sottili. Progettata con un angolo di taglio altamente positivo, T-land stretto e arrotondamento del tagliente per lavorazioni leggere.

| | | | | | | | | | | | | | | | | | | | | |
|-----------------|-------|-----|-----|------|-----|-----|------|-----|---|---|---|---|---|---|----|------|-----|---|---|---|
| ONMX 060508SR-F | 8215 | 0.8 | 275 | 0.10 | 2.0 | 165 | 0.09 | 2.0 | - | - | - | - | - | - | 65 | 0.07 | 1.6 | - | - | - |
| | M6330 | 0.8 | 230 | 0.10 | 2.0 | 165 | 0.09 | 2.0 | - | - | - | - | - | - | 65 | 0.07 | 1.6 | - | - | - |
| | M8330 | 0.8 | 270 | 0.10 | 2.0 | 160 | 0.09 | 2.0 | - | - | - | - | - | - | 65 | 0.07 | 1.6 | - | - | - |
| | M8340 | 0.8 | 245 | 0.10 | 2.0 | 145 | 0.09 | 2.0 | - | - | - | - | - | - | 60 | 0.07 | 1.6 | - | - | - |
| | M9340 | 0.8 | 320 | 0.10 | 2.0 | 190 | 0.09 | 2.0 | - | - | - | - | - | - | 80 | 0.07 | 1.6 | - | - | - |

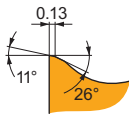

La geometria versatile M rappresenta la prima scelta per una vasta gamma di condizioni di lavoro. Progettata con un angolo di taglio positivo, T-land medio e arrotondamento del tagliente per lavorazioni medie.

| | | | | | | | | | | | | | | | | | | | | |
|-----------------|-------|-----|-----|------|-----|-----|------|-----|---|---|---|---|---|---|----|------|-----|----|------|-----|
| ONMX 060508SR-M | 8215 | 0.8 | 230 | 0.20 | 2.0 | 135 | 0.18 | 2.0 | - | - | - | - | - | - | 55 | 0.14 | 1.6 | 45 | 0.14 | 1.0 |
| | M6330 | 0.8 | 195 | 0.20 | 2.0 | 140 | 0.18 | 2.0 | - | - | - | - | - | - | 55 | 0.14 | 1.6 | - | - | - |
| | M8330 | 0.8 | 230 | 0.20 | 2.0 | 135 | 0.18 | 2.0 | - | - | - | - | - | - | 55 | 0.14 | 1.6 | 45 | 0.14 | 1.0 |
| | M8340 | 0.8 | 210 | 0.20 | 2.0 | 125 | 0.18 | 2.0 | - | - | - | - | - | - | 50 | 0.14 | 1.6 | - | - | - |
| | M9325 | 0.8 | 285 | 0.20 | 2.0 | - | - | - | - | - | - | - | - | - | - | - | - | 55 | 0.14 | 1.0 |
| | M9340 | 0.8 | 255 | 0.20 | 2.0 | 150 | 0.18 | 2.0 | - | - | - | - | - | - | 60 | 0.14 | 1.6 | - | - | - |



Idoneità e valori iniziali per velocità di taglio (Vc), avanzamento (f) e profondità di taglio (ap). Fare riferimento alla nostra App Machining Calculator per ulteriori calcoli.

| Prodotto | RE (mm) | P | | | M | | | K | | | N | | | S | | | H | | |
|----------|------------|---------------|-----------------|------------|---------------|-----------------|------------|---------------|-----------------|------------|---------------|-----------------|------------|---------------|-----------------|------------|---------------|-----------------|------------|
| | | vc (m/min) | f (mm/tooth) | ap (mm) | vc (m/min) | f (mm/tooth) | ap (mm) | vc (m/min) | f (mm/tooth) | ap (mm) | vc (m/min) | f (mm/tooth) | ap (mm) | vc (m/min) | f (mm/tooth) | ap (mm) | vc (m/min) | f (mm/tooth) | ap (mm) |

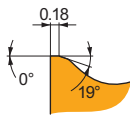

La geometria robusta R è utilizzata per la sgrossatura e condizioni di lavoro pesanti. Progettata con un angolo di taglio leggermente positivo, T-land ampio e arrotondamento del tagliente per lavorazioni di sgrossatura.

| | | | | | | | | | | | | | | | | | | | | | | |
|------------------------|--------------|-----|---|-----|------|-----|---|---|---|---|---|-----|------|-----|---|---|---|---|---|----|------|-----|
| ONMX 060508SR-R | 8215 | 0.8 | ■ | 210 | 0.30 | 2.0 | ■ | — | — | — | ■ | 195 | 0.30 | 2.0 | ■ | — | — | — | ■ | 40 | 0.21 | 1.0 |
| | M5315 | 0.8 | ▣ | 255 | 0.30 | 2.0 | ■ | — | — | — | ■ | 240 | 0.30 | 2.0 | ■ | — | — | — | ■ | 50 | 0.21 | 1.0 |
| | M8330 | 0.8 | ■ | 210 | 0.30 | 2.0 | ■ | — | — | — | ■ | 195 | 0.30 | 2.0 | ■ | — | — | — | ▣ | 40 | 0.21 | 1.0 |
| | M8340 | 0.8 | ■ | 190 | 0.30 | 2.0 | ■ | — | — | — | ▣ | 180 | 0.30 | 2.0 | ■ | — | — | — | ■ | — | — | — |
| | M9325 | 0.8 | ■ | 250 | 0.30 | 2.0 | ■ | — | — | — | ■ | 235 | 0.30 | 2.0 | ■ | — | — | — | ▣ | 50 | 0.21 | 1.0 |

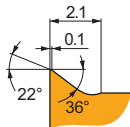
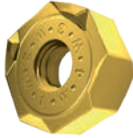

Design raschiante volto a garantire una migliore finitura superficiale durante la lavorazione con frese di grandi dimensioni e avanzamenti elevati.

| | | | | | | | | | | | | | | | | | | | | | | |
|------------------------|--------------|-----|---|-----|------|-----|---|-----|------|-----|---|---|---|---|---|---|---|---|---|---|---|---|
| ONMX 060508SR-W | 8215 | 0.8 | ■ | 340 | 0.10 | 0.3 | ▣ | 200 | 0.09 | 0.3 | ■ | — | — | — | ■ | — | — | — | ■ | — | — | — |
| | M8330 | 0.8 | ■ | 325 | 0.10 | 0.3 | ■ | 195 | 0.09 | 0.3 | ■ | — | — | — | ■ | — | — | — | ■ | — | — | — |

SNMX 17



| IC (mm) | D1 (mm) | S (mm) |
|------------|------------|-----------|
| 1705 | 17.000 | 5.70 |

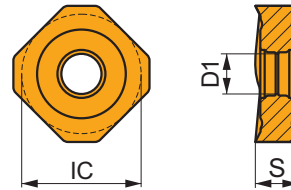

Idoneità e valori iniziali per velocità di taglio (Vc), avanzamento (f) e profondità di taglio (ap). Fare riferimento alla nostra App Machining Calculator per ulteriori calcoli.

| Prodotto | RE (mm) | P | | | M | | | K | | | N | | | S | | | H | | |
|----------|------------|---------------|-----------------|------------|---------------|-----------------|------------|---------------|-----------------|------------|---------------|-----------------|------------|---------------|-----------------|------------|---------------|-----------------|------------|
| | | vc (m/min) | f (mm/tooth) | ap (mm) | vc (m/min) | f (mm/tooth) | ap (mm) | vc (m/min) | f (mm/tooth) | ap (mm) | vc (m/min) | f (mm/tooth) | ap (mm) | vc (m/min) | f (mm/tooth) | ap (mm) | vc (m/min) | f (mm/tooth) | ap (mm) |

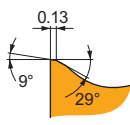
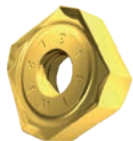

La geometria versatile M rappresenta la prima scelta per una vasta gamma di condizioni di lavoro. Progettata con un angolo di taglio positivo, T-land medio e arrotondamento del tagliente per lavorazioni medie.

| | | | | | | | | | | | | | | | | | | | | | | |
|------------------------|--------------|-----|---|-----|------|-----|---|-----|------|-----|---|---|---|---|---|----|------|-----|---|----|------|-----|
| SNMX 170508SR-M | 8215 | 0.8 | ■ | 265 | 0.20 | 4.0 | ▣ | 155 | 0.18 | 4.0 | ■ | — | — | — | ▣ | 65 | 0.14 | 3.2 | ■ | 50 | 0.14 | 1.0 |
| | M6330 | 0.8 | ■ | 225 | 0.20 | 4.0 | ▣ | 160 | 0.18 | 4.0 | ■ | — | — | — | ▣ | 65 | 0.14 | 3.2 | ■ | — | — | — |
| | M8330 | 0.8 | ■ | 265 | 0.20 | 4.0 | ▣ | 155 | 0.18 | 4.0 | ■ | — | — | — | ▣ | 65 | 0.14 | 3.2 | ▣ | 50 | 0.14 | 1.0 |
| | M8340 | 0.8 | ■ | 240 | 0.20 | 4.0 | ▣ | 140 | 0.18 | 4.0 | ■ | — | — | — | ▣ | 60 | 0.14 | 3.2 | ■ | — | — | — |
| | M9325 | 0.8 | ■ | 325 | 0.20 | 4.0 | ■ | — | — | — | ■ | — | — | — | ■ | — | — | — | ▣ | 65 | 0.14 | 1.0 |
| | M9340 | 0.8 | ■ | 295 | 0.20 | 4.0 | ▣ | 175 | 0.18 | 4.0 | ■ | — | — | — | ▣ | 70 | 0.14 | 3.2 | ■ | — | — | — |

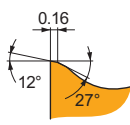
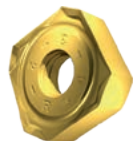

La geometria robusta R è utilizzata per la sgrossatura e condizioni di lavoro pesanti. Progettata con un angolo di taglio leggermente positivo, T-land ampio e arrotondamento del tagliente per lavorazioni di sgrossatura.

| | | | | | | | | | | | | | | | | | | | | | | |
|------------------------|--------------|-----|---|-----|------|-----|---|---|---|---|---|-----|------|-----|---|---|---|---|---|----|------|-----|
| SNMX 170508SR-R | 8215 | 0.8 | ■ | 240 | 0.30 | 4.0 | ■ | — | — | — | ■ | 225 | 0.30 | 4.0 | ■ | — | — | — | ■ | 45 | 0.21 | 1.0 |
| | M5315 | 0.8 | ▣ | 300 | 0.30 | 4.0 | ■ | — | — | — | ■ | 285 | 0.30 | 4.0 | ■ | — | — | — | ■ | 60 | 0.21 | 1.0 |
| | M8330 | 0.8 | ■ | 240 | 0.30 | 4.0 | ■ | — | — | — | ■ | 225 | 0.30 | 4.0 | ■ | — | — | — | ▣ | 45 | 0.21 | 1.0 |
| | M8340 | 0.8 | ■ | 220 | 0.30 | 4.0 | ■ | — | — | — | ▣ | 205 | 0.30 | 4.0 | ■ | — | — | — | ■ | — | — | — |
| | M9325 | 0.8 | ■ | 290 | 0.30 | 4.0 | ■ | — | — | — | ■ | 275 | 0.30 | 4.0 | ■ | — | — | — | ▣ | 55 | 0.21 | 1.0 |



| a_s / DC | 5% | 10% | 15% | 20% | 25% | 30% | 40% | 50% | 60% | 70% | 75% | 80% | 90% | 100% |
|------------|------|------|------|------|------|------|------|------|------|------|------|------|------|------|
| | 1.48 | 1.35 | 1.27 | 1.22 | 1.19 | 1.16 | 1.11 | 1.08 | 1.05 | 1.03 | 1.00 | 1.00 | 1.00 | 1.00 |
| | 2.20 | 1.60 | 1.35 | 1.20 | 1.10 | 0.95 | 0.85 | 0.75 | 0.85 | 0.95 | 1.00 | 1.00 | 1.00 | 1.00 |
| | 0.64 | 0.64 | 0.64 | 0.64 | 0.64 | 0.65 | 0.65 | 0.67 | 0.68 | 0.71 | 0.72 | 0.74 | 0.79 | 1.00 |

| | ONMX 06-F | ONMX 06-M | ONMX 06-R | ONMX 06-W | SNMX 17-M | SNMX 17-R |
|--|-----------|-----------|-----------|-----------|-----------|-----------|
| | 0.80 | 0.80 | 0.80 | 0.80 | 0.80 | 0.80 |
| | 0.75 | 0.75 | 0.75 | 4.30 | 0.70 | 0.70 |

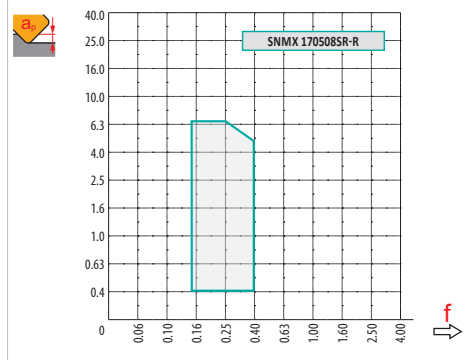
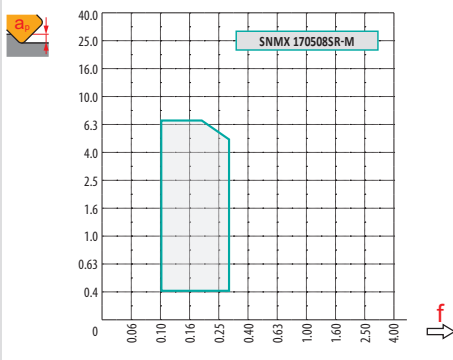
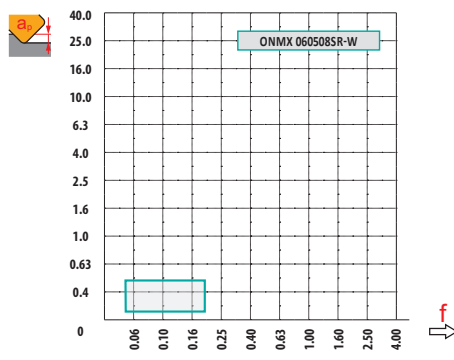
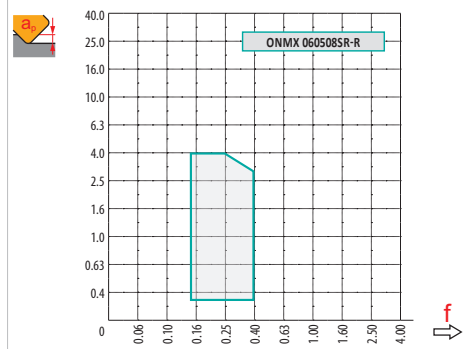
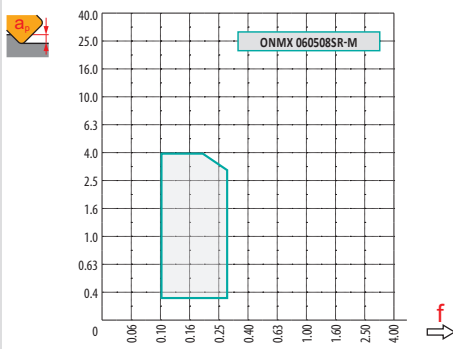
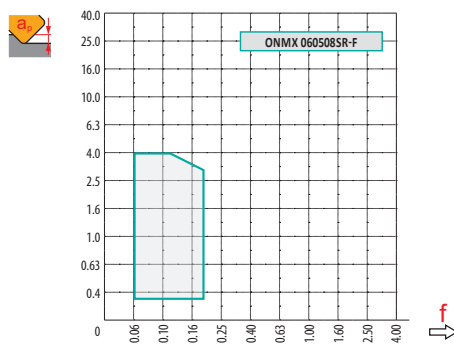

| | | 0.50 | 1.00 | 1.50 | 2.00 | 2.50 | 3.00 | 3.50 | 4.00 |
|-----|--|--------|--------|--------|--------|--------|--------|--------|--------|
| 50 | | 51.06 | 52.11 | 53.19 | 54.27 | 55.35 | 56.43 | 57.51 | 58.59 |
| 63 | | 64.06 | 65.11 | 66.19 | 67.27 | 68.35 | 69.43 | 70.51 | 71.59 |
| 80 | | 81.06 | 82.11 | 83.19 | 84.27 | 85.35 | 86.43 | 87.51 | 88.59 |
| 100 | | 101.06 | 102.11 | 103.19 | 104.27 | 105.35 | 106.43 | 107.51 | 108.59 |
| 125 | | 126.06 | 127.11 | 128.19 | 129.27 | 130.35 | 131.43 | 132.51 | 133.59 |
| 160 | | 161.06 | 162.11 | 163.19 | 164.27 | 165.35 | 166.43 | 167.51 | 168.59 |
| 200 | | 201.06 | 202.11 | 203.19 | 204.27 | 205.35 | 206.43 | 207.51 | 208.59 |
| 250 | | 251.06 | 252.11 | 253.19 | 254.27 | 255.35 | 256.43 | 257.51 | 258.59 |



| DC | a _p | S | | | | | | | |
|-----|----------------|--------|--------|--------|--------|--------|--------|--------|--------|
| | | 0.00 | 1.00 | 2.00 | 3.00 | 4.00 | 5.00 | 6.00 | 7.00 |
| 50 | DEF | 47.24 | 49.40 | 51.56 | 53.73 | 55.90 | 58.06 | 60.23 | 62.40 |
| 63 | | 60.24 | 62.40 | 64.56 | 66.73 | 68.90 | 71.06 | 73.23 | 75.40 |
| 80 | | 77.24 | 79.40 | 81.56 | 83.73 | 85.90 | 88.06 | 90.23 | 92.40 |
| 100 | | 97.24 | 99.40 | 101.56 | 103.73 | 105.90 | 108.06 | 110.23 | 112.40 |
| 125 | | 122.24 | 124.40 | 126.56 | 128.73 | 130.90 | 133.06 | 135.23 | 137.40 |
| 160 | | 157.24 | 159.40 | 161.56 | 163.73 | 165.90 | 168.06 | 170.23 | 172.40 |
| 200 | | 197.24 | 199.40 | 201.56 | 203.73 | 205.90 | 208.06 | 210.23 | 212.40 |
| 250 | | 247.24 | 249.40 | 251.56 | 253.73 | 255.90 | 258.06 | 260.23 | 262.40 |

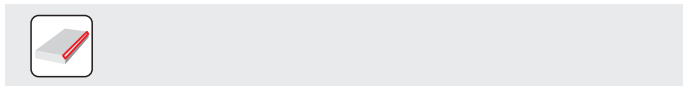

| DC | X.V | f _{max} |
|-----|------|------------------|
| 50 | 1.35 | 0.36 |
| 63 | 1.39 | 0.40 |
| 80 | 1.44 | 0.45 |
| 100 | 1.48 | 0.51 |
| 125 | 1.53 | 0.57 |
| 160 | 1.58 | 0.64 |
| 200 | 1.63 | 0.72 |
| 250 | 1.68 | 0.80 |

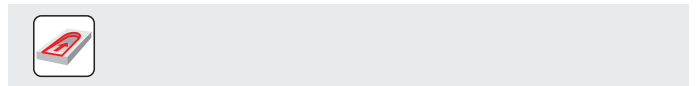

| DC | O | |
|-----|------|----------|
| | RPMX | APMX/I |
| 50 | 0.3 | 0.4/100 |
| 63 | 0.2 | 0.25/100 |
| 80 | 0.2 | 0.2/100 |
| 100 | 0.1 | 0.1/100 |
| 125 | 0.1 | 0.05/100 |

| DC | S | |
|-------|------|----------|
| | RPMX | APMX/I |
| 47.24 | 0.1 | 0.1/100 |
| 60.24 | 0.1 | 0.05/100 |
| 77.24 | 0.1 | 0.05/100 |

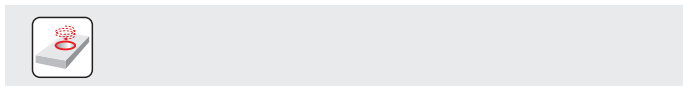

| DC | O | | | |
|-----|------|------|------------|------------|
| | DMIN | DMAX | S MAX DMIN | S MAX DMAX |
| 50 | 98 | 110 | 0.55 | 0.95 |
| 63 | 123 | 136 | 0.55 | 0.85 |
| 80 | 157 | 170 | 0.65 | 0.85 |
| 100 | 197 | 210 | 0.65 | 0.8 |
| 125 | 247 | 260 | 0.65 | 0.8 |
| 160 | 317 | 330 | 0.6 | 0.7 |
| 200 | 397 | 410 | 0.7 | 0.8 |
| 250 | 497 | 510 | 0.6 | 0.7 |

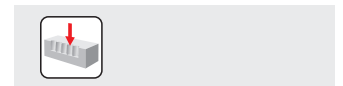

| O |
|------|
| 11.5 |

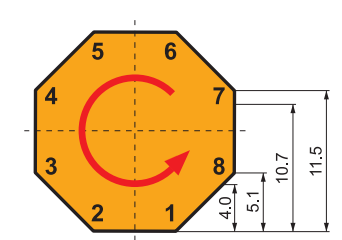
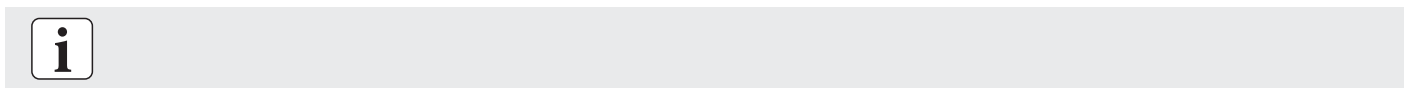

| a _p | Count |
|----------------|-------|
| 4.0 | 16 |
| 5.1 | 14 |
| 10.7 | 8 |
| 11.5 | 6 |

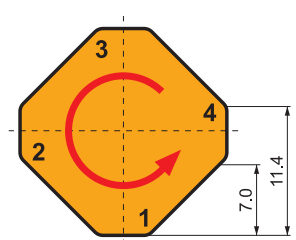

| a _p | Count |
|----------------|-------|
| 7.0 | 8 |
| 11.4 | 4 |

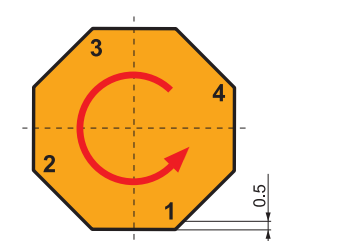

| ONMX 06-W | |
|----------------|-------|
| a _p | Count |
| 0.5 | 8 |



DORMER PRAMET



TUTTO IN UNO

Tutte le nostre pubblicazioni raggruppate in un'unica posizione e aggiornate con le ultime versioni. Che cosa state aspettando? Scaricate la nostra library App oggi stesso dal vostro app store. **Simply Reliable.**

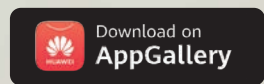
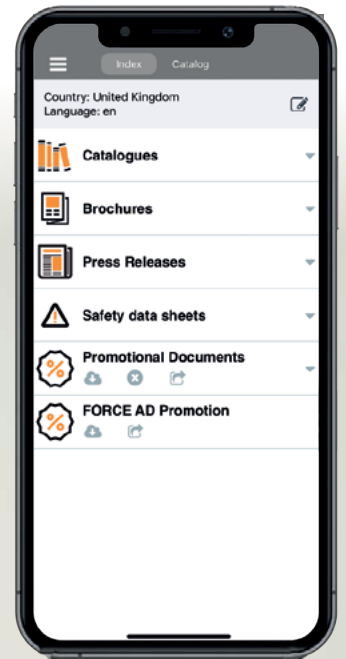



SSD13F

FRESATURA SPIANATURA VERSATILE

INTRODUZIONE



E' stata introdotta una nuova gamma di frese di spianatura per la meccanica generale. Questa gamma Pramet comprende due inserti, uno sinterizzato di precisione ed uno preciso (SDMT e SDET) per profondità di taglio fino a 6.4 mm. Qualità e geometrie inserti disponibili per la lavorazione di un'ampia gamma di materiali.



SDMT-M

- Insetto stampato versatile
- Acciaio, ghisa e acciaio duro
- Taglio medio



SDMT-R

- Insetto stampato versatile
- Acciaio, ghisa e acciaio duro
- Sgrossatura



CARATTERISTICHE E VANTAGGI DEGLI INSERTI

Geometrie e qualità specifiche per le diverse applicazioni.

FACILE DA SELEZIONARE E UTILIZZARE
per un'ampia gamma di materiali da lavorare

Inserto stampato nelle geometrie M e R (SDMT 13).

TAGLIO LEGGERO, MEDIO E PESANTE
su acciaio, ghisa e acciaio duro

Inserto rettificato con geometria F affilata (SDET 13).

LAVORAZIONE SICURA
di acciai inossidabili e superleghe resistenti al calore (HRSA).

Inserto rettificato in geometria FA affilata e lappata (SDET 13).

FRESATURA PRODUTTIVA
dei materiali non ferrosi.

Tutte le geometrie presentano un tratto Wiper sui taglienti.

ELEVATA QUALITÀ SUPERFICIALE
per molteplici applicazioni, dalla sgrossatura pesante alla finitura.

Disponibile inserto raschiante aggiuntivo XDET 13.

PRODUTTIVITÀ ED ELEVATA QUALITÀ SUPERFICIALE
con frese di grandi diametri.

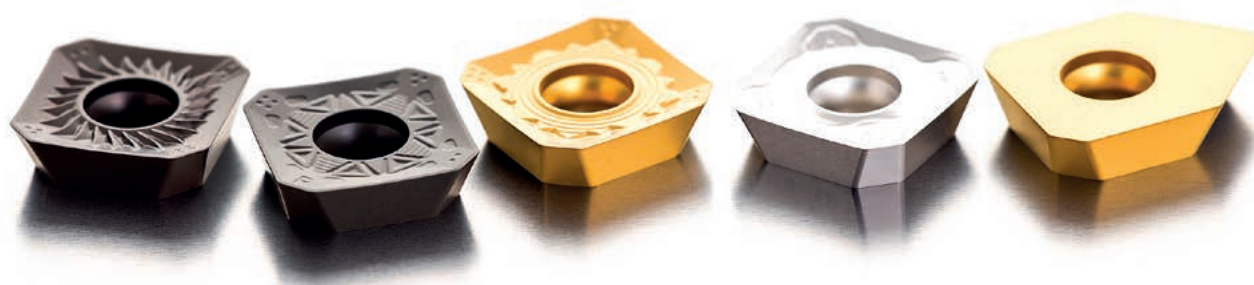

SDET-F

- Inserto rettificato preciso
- Acciaio inox e HRSA
- Taglio leggero e medio

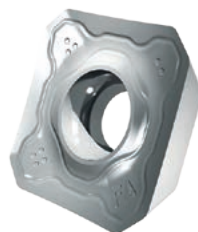

SDET-FA

- Inserto rettificato preciso
- Materiali non ferrosi
- Taglio da leggero a pesante

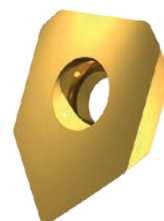

XDET

- Inserto Wiper
- Acciaio, ghisa, inox
- Qualità di finitura elevata

**SSD13F****FRESATURA SPIANATURA VERSATILE****CORPI FRESA SSD13F – CARATTERISTICHE E VANTAGGI**

Frese con attacco Weldon ed a manicotto nei diametri 32 – 250 mm (1.25 – 10.00 pollici).

**AMPIA SCELTA**

per diverse tipologie di macchine utensili.

Sottopiacchetta in metallo duro nella sede inserto.

**PROTEZIONE EXTRA PER UN'ELEVATA DURATA**

del corpo fresa, fornendo allo stesso tempo stabilità all'inserto e sicurezza del processo.

Refrigerante interno su tutta la gamma, compresi i diametri di grandi dimensioni.

**MAGGIORE DURATA DELL'UTENSILE**

e migliore evacuazione del truciolo, fornendo un'elevata qualità superficiale ed affidabilità.



SSD13F

- Attacco Weldon
- Gamma DC
32 – 40 mm
1.25 – 1.50 pollici



SSD13F

- Attacco a manicotto
- Gamma DC
40 – 250 mm
1.50 – 10.00 pollici

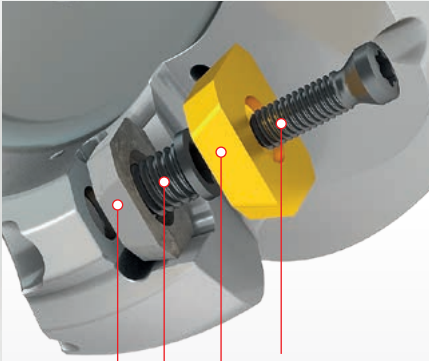

Vite inserto
Inserto
Vite sottopiacchetta
Sottopiacchetta



ESEMPI DI FRESATURA A SPIANARE

Particolare: Piastra in acciaio al C (215 HB)
 Materiale: 1.1191 / C45
 Fresa: 63A05R-S45SD13F-C
 Refrigerante: Aria

| Dati di taglio | | | |
|-----------------------|------------|------------|--------------|
| v_c (m/min) | f_z (mm) | a_p (mm) | a_e (mm) |
| 250 | 0.25 | 2 | 50 |
| Inserto | | | Durata (min) |
| SDMT 13T3AFSN-M:M8330 | | | 97 |

SDMT 13T3AFSN-M:M8330, 97 min



WMG P2.2

Particolare: Piastra in inox (145 HB)
 Materiale: 1.4404 / 316L
 Fresa: 63A05R-S45SD13F-C
 Refrigerante: Aria

| Dati di taglio | | | |
|-----------------------|------------|------------|--------------|
| v_c (m/min) | f_z (mm) | a_p (mm) | a_e (mm) |
| 120 | 0.15 | 2 | 50 |
| Inserto | | | Durata (min) |
| SDET 13T3AFSN-F:M6330 | | | 42 |

SDET 13T3AFSN-F:M6330, 42 min



WMG M3.1

Particolare: Piastra in inox (145 HB)
 Materiale: 1.4404 / 316L
 Fresa: 63A05R-S45SD13F-C
 Refrigerante: Emulsione al ~ 10%

| Dati di taglio | | | |
|-----------------------|------------|------------|--------------|
| v_c (m/min) | f_z (mm) | a_p (mm) | a_e (mm) |
| 80 | 0.15 | 2 | 50 |
| Inserto | | | Durata (min) |
| SDET 13T3AFSN-F:M6330 | | | 100 |

SDET 13T3AFSN-F:M6330, 100 min

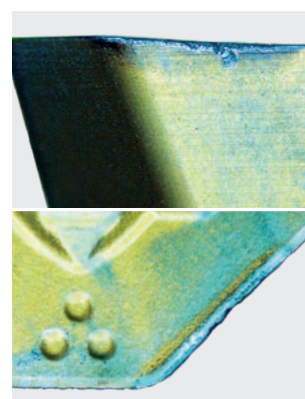

WMG M3.1

Particolare: Piastra in ghisa (205 HB)
 Materiale: GG25 / FC250
 Fresa: 63A05R-S45SD13F-C
 Refrigerante: Aria

| Dati di taglio | | | |
|-----------------------|------------|------------|--------------|
| v_c (m/min) | f_z (mm) | a_p (mm) | a_e (mm) |
| 300 | 0.4 | 2 | 50 |
| Inserto | | | Durata (min) |
| SDMT 13T3AFSN-R:M5315 | | | 42 |

SDMT 13T3AFSN-R:M5315, 42 min

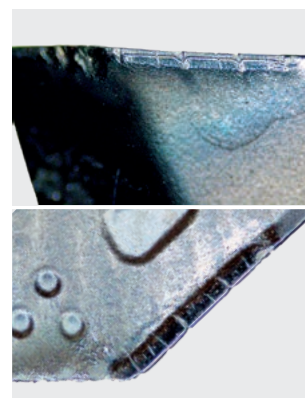

WMG K1.2



SSD13F



PRAMET

S



VER SD13 Fresa per operazioni di spianatura a 45° con geometria positiva e passaggio refrigerante interno

Fresa per operazioni di spianatura a 45° altamente versatile, che prevede l'utilizzo inserti di tipo SD.. 13 inserti con APMX di 6,4 mm. Adatta per una vasta gamma di applicazioni in pezzi da lavorare di qualunque materiale. Disponibilità di corpi fresa con attacchi weldon e a manicotto, con passo differenziato dei denti. Corpo trattato per una maggiore vita utensile, supporti in metallo duro sulla sede inserto per una sicurezza del processo ottimale.

| | |
|------|--------|
| KAPR | 45° |
| APMX | 6.4 mm |

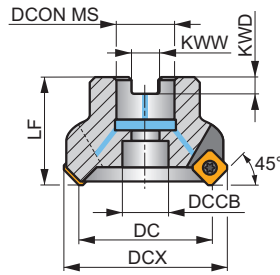
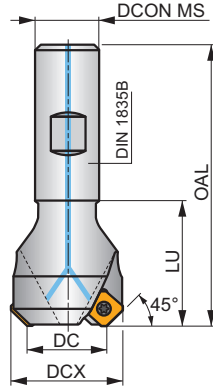
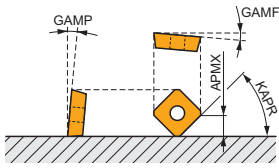

DC 40 – 125 mm

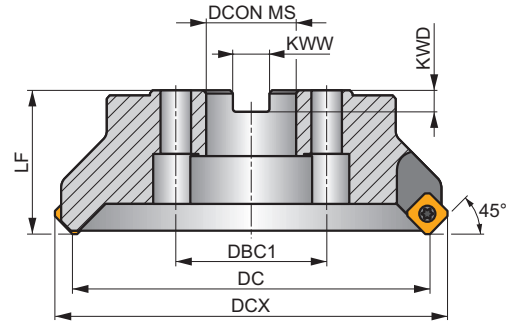

DC 160 – 250 mm

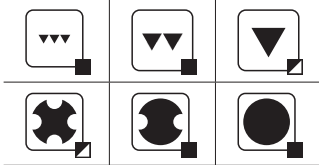

| | |
|--|-------------|
| | 0.04 - 0.32 |
| | 0.04 - 0.28 |



| Prodotto | DC | DCX | OAL | DCON MS | DCCB | DBC1 | LU | LF | KWW | KWD | GAMF | GAMP | max. | | kg | C | | | | |
|----------------------|------|-------|------|---------|------|-------|------|------|------|------|------|------|------|---|-------|---|-------|-------|-------|-------|
| | (mm) | (mm) | (mm) | (mm) | (mm) | (mm) | (mm) | (mm) | (mm) | (mm) | (°) | (°) | | | | | | | | |
| 32N3R045B25-SSD13F-C | 32 | 44.9 | 120 | 25 | - | - | 45 | - | - | - | -15 | 15 | 3 | - | 16100 | ✓ | 0.43 | GI341 | C0610 | - |
| 40N3R045B32-SSD13F-C | 40 | 53.5 | 120 | 32 | - | - | 45 | - | - | - | -7 | 15 | 3 | - | 14400 | ✓ | 0.72 | GI341 | C0610 | - |
| 40A03R-S45SD13F-C | 40 | 53.5 | - | 16 | 14 | - | - | 40 | 8.4 | 5.6 | -7 | 15 | 3 | - | 14400 | ✓ | 0.27 | GI341 | C0611 | - |
| 50A04R-S45SD13F-C | 50 | 63.5 | - | 22 | 18 | - | - | 40 | 10.4 | 6.3 | -7 | 15 | 4 | ✓ | 12900 | ✓ | 0.51 | GI341 | C0612 | - |
| 63A05R-S45SD13F-C | 63 | 76.4 | - | 22 | 18 | - | - | 40 | 10.4 | 6.3 | -7 | 15 | 5 | ✓ | 11500 | ✓ | 0.53 | GI341 | C0612 | - |
| 80A07R-S45SD13F-C | 80 | 93.4 | - | 27 | 22 | - | - | 50 | 12.4 | 7 | -7 | 15 | 7 | ✓ | 10200 | ✓ | 1.32 | GI341 | C0613 | AC001 |
| 100A08R-S45SD13F-C | 100 | 112.9 | - | 32 | 45 | - | - | 50 | 14.4 | 8 | -12 | 15 | 8 | ✓ | 9100 | ✓ | 1.83 | GI341 | C0613 | AC002 |
| 100A10R-S45SD13F-C | 100 | 112.9 | - | 32 | 45 | - | - | 50 | 14.4 | 8 | -12 | 15 | 10 | - | 9100 | ✓ | 1.94 | GI341 | C0613 | AC002 |
| 125A08R-S45SD13F-C | 125 | 137.8 | - | 40 | 56 | - | - | 63 | 16.4 | 9 | -12 | 15 | 8 | ✓ | 8100 | ✓ | 3.41 | GI341 | C0613 | AC003 |
| 125A12R-S45SD13F-C | 125 | 137.8 | - | 40 | 56 | - | - | 63 | 16.4 | 9 | -12 | 15 | 12 | - | 8100 | ✓ | 3.31 | GI341 | C0613 | AC003 |
| 160C10R-S45SD13F-C | 160 | 172.8 | - | 40 | - | 66.7 | - | 63 | 16.4 | 9 | -12 | 15 | 10 | ✓ | 7200 | ✓ | 6.69 | GI341 | C0614 | - |
| 160C14R-S45SD13F-C | 160 | 172.8 | - | 40 | - | 66.7 | - | 63 | 16.4 | 9 | -12 | 15 | 14 | ✓ | 7200 | ✓ | 6.62 | GI341 | C0614 | - |
| 200C12R-S45SD13F-C | 200 | 212.8 | - | 60 | - | 101.6 | - | 63 | 25.7 | 14 | -12 | 15 | 12 | ✓ | 6400 | ✓ | 9.06 | GI341 | C0615 | - |
| 200C16R-S45SD13F-C | 200 | 212.8 | - | 60 | - | 101.6 | - | 63 | 25.7 | 14 | -12 | 15 | 16 | ✓ | 6400 | ✓ | 11.85 | GI341 | C0615 | - |
| 250C14R-S45SD13F-C | 250 | 262.8 | - | 60 | - | 101.6 | - | 63 | 25.7 | 14 | -12 | 15 | 14 | ✓ | 5700 | ✓ | 19.50 | GI341 | C0616 | - |
| 250C20R-S45SD13F-C | 250 | 262.8 | - | 60 | - | 101.6 | - | 63 | 25.7 | 14 | -12 | 15 | 20 | ✓ | 5700 | ✓ | 19.20 | GI341 | C0616 | - |

| | | | |
|-------|-------------|-------------|-------------|
| | | | |
| GI341 | SDET 13T3.. | SDMT 13T3.. | XDET 13T3.. |



| | | | | | | | | | | | | | | |
|-------|---------------|-----|-------|----|-----------|-------------|-------|-----------|------------|---------|---------|----------|-----------|-------|
| | | | | | | | | | | | | | | |
| CO610 | US 63513-T15P | 3.0 | M 3.5 | 13 | Flag T15P | – | – | – | SDW 1103AF | MS 3507 | HXK 3.5 | – | – | – |
| CO611 | US 63513-T15P | 3.0 | M 3.5 | 13 | – | D-T08P/T15P | FG-15 | HS 0830C | SDW 1103AF | MS 3507 | HXK 3.5 | – | – | – |
| CO612 | US 63513-T15P | 3.0 | M 3.5 | 13 | – | D-T08P/T15P | FG-15 | HSD 1025C | SDW 1103AF | MS 3507 | HXK 3.5 | – | – | – |
| CO613 | US 63513-T15P | 3.0 | M 3.5 | 13 | – | D-T08P/T15P | FG-15 | – | SDW 1103AF | MS 3507 | HXK 3.5 | – | – | – |
| CO614 | US 63513-T15P | 3.0 | M 3.5 | 13 | – | D-T08P/T15P | FG-15 | HS 1240C | SDW 1103AF | MS 3507 | HXK 3.5 | CAC 160C | HSD 0825C | HXK 5 |
| CO615 | US 63513-T15P | 3.0 | M 3.5 | 13 | – | D-T08P/T15P | FG-15 | HS 1655C | SDW 1103AF | MS 3507 | HXK 3.5 | CAC 200C | HSD 1025C | HXK 7 |
| CO616 | US 63513-T15P | 3.0 | M 3.5 | 13 | – | D-T08P/T15P | FG-15 | HS 1655C | SDW 1103AF | MS 3507 | HXK 3.5 | CAC 250C | HSD 1025C | HXK 7 |

| | | |
|-------|---------|---------|
| | | |
| AC001 | KS 1230 | K.FMH27 |
| AC002 | KS 1635 | K.FMH32 |
| AC003 | KS 2040 | K.FMH40 |

SDET 13



| | IC | D1 | M | S |
|------|--------|------|------|------|
| | (mm) | (mm) | (mm) | (mm) |
| 13T3 | 13.385 | 4.40 | 1.5 | 3.97 |

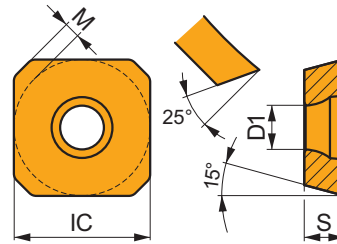

Idoneità e valori iniziali per velocità di taglio (Vc), avanzamento (f) e profondità di taglio (ap). Fare riferimento alla nostra App Machining Calculator per ulteriori calcoli.

| Prodotto | RE | P | | | M | | | K | | | N | | | S | | | H | | |
|----------|------|---------|------------|------|---------|------------|------|---------|------------|------|---------|------------|------|---------|------------|------|---------|------------|------|
| | | vc | f | ap | vc | f | ap | vc | f | ap | vc | f | ap | vc | f | ap | vc | f | ap |
| | (mm) | (m/min) | (mm/tooth) | (mm) | (m/min) | (mm/tooth) | (mm) | (m/min) | (mm/tooth) | (mm) | (m/min) | (mm/tooth) | (mm) | (m/min) | (mm/tooth) | (mm) | (m/min) | (mm/tooth) | (mm) |

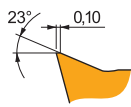

La geometria positiva F è utilizzata per la finitura, adatta per sbalzi elevati o per applicazioni caratterizzate da pareti e pezzi da lavorare sottili. Progettata con un angolo di taglio altamente positivo, T-land stretto e arrotondamento del tagliente per lavorazioni leggere.

| | | | | | | | | | | | | | | | | | | | | | |
|-----------------|-------|---|-----|------|-----|-----|------|-----|-----|------|-----|-----|------|-----|----|------|------|-----|---|---|---|
| SDET 13T3AFSN-F | M6330 | – | 250 | 0.15 | 3.0 | 175 | 0.14 | 3.0 | – | – | – | – | – | – | – | 70 | 0.11 | 2.4 | – | – | – |
| | M8310 | – | 315 | 0.15 | 3.0 | 160 | 0.14 | 3.0 | 295 | 0.15 | 3.0 | – | – | – | – | – | – | – | – | – | – |
| | M8330 | – | 285 | 0.15 | 3.0 | 170 | 0.14 | 3.0 | 270 | 0.15 | 3.0 | 855 | 0.18 | 3.0 | 70 | 0.11 | 2.4 | – | – | – | – |
| | M8340 | – | 265 | 0.15 | 3.0 | 155 | 0.14 | 3.0 | 250 | 0.15 | 3.0 | – | – | – | 65 | 0.11 | 2.4 | – | – | – | – |
| | M9340 | – | 330 | 0.15 | 3.0 | 195 | 0.14 | 3.0 | – | – | – | – | – | – | 80 | 0.11 | 2.4 | – | – | – | – |

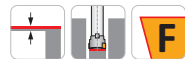
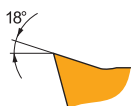
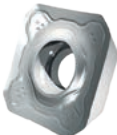

La geometria FA è affilata e utilizzata per la lavorazione di leghe non ferrose, adatta per sbalzi elevati o per applicazioni caratterizzate da pareti e pezzi da lavorare sottili. Design lappatura superficiale con angolo di taglio altamente positivo.

| | | | | | | | | | | | | | | | | | | | | | |
|------------------|-------|---|---|---|---|---|---|---|---|---|---|-----|------|-----|---|---|---|---|---|---|---|
| SDET 13T3AFFN-FA | HF7 | – | – | – | – | – | – | – | – | – | – | 360 | 0.12 | 3.0 | – | – | – | – | – | – | – |
| | M0315 | – | – | – | – | – | – | – | – | – | – | 840 | 0.12 | 3.0 | – | – | – | – | – | – | – |



SDMT 13

PRAMET

| | IC | D1 | M | S |
|------|--------|------|------|------|
| | (mm) | (mm) | (mm) | (mm) |
| 13T3 | 13.385 | 4.40 | 1.5 | 3.97 |

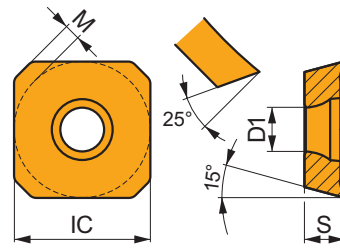

Idoneità e valori iniziali per velocità di taglio (Vc), avanzamento (f) e profondità di taglio (ap). Fare riferimento alla nostra App Machining Calculator per ulteriori calcoli.

| Prodotto | RE | P | | | M | | | K | | | N | | | S | | | H | | |
|----------|------|---------|------------|------|---------|------------|------|---------|------------|------|---------|------------|------|---------|------------|------|---------|------------|------|
| | | vc | f | ap | vc | f | ap | vc | f | ap | vc | f | ap | vc | f | ap | vc | f | ap |
| | (mm) | (m/min) | (mm/tooth) | (mm) | (m/min) | (mm/tooth) | (mm) | (m/min) | (mm/tooth) | (mm) | (m/min) | (mm/tooth) | (mm) | (m/min) | (mm/tooth) | (mm) | (m/min) | (mm/tooth) | (mm) |

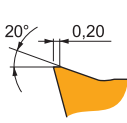

La geometria versatile M rappresenta la prima scelta per una vasta gamma di condizioni di lavoro. Progettata con un angolo di taglio positivo, T-land medio e arrotondamento del tagliente per lavorazioni medie.

| | | | | | | | | | | | | | | | | | | | | | | | | | |
|------------------------|--------------|---|---|-----|------|-----|---|-----|------|-----|---|-----|------|-----|---|---|---|---|----|------|-----|---|----|------|-----|
| SDMT 13T3AFSN-M | 8215 | – | ■ | 245 | 0.30 | 3.0 | ✓ | 145 | 0.27 | 3.0 | ■ | 230 | 0.30 | 3.0 | – | – | – | ✓ | 60 | 0.24 | 2.4 | ■ | 45 | 0.21 | 1.0 |
| | M6330 | – | ■ | 215 | 0.30 | 3.0 | ■ | 150 | 0.27 | 3.0 | – | – | – | – | – | – | – | ■ | 60 | 0.24 | 2.4 | – | – | – | |
| | M8330 | – | ■ | 245 | 0.30 | 3.0 | ■ | 145 | 0.27 | 3.0 | ■ | 230 | 0.30 | 3.0 | – | – | – | ■ | 60 | 0.24 | 2.4 | ✓ | 45 | 0.21 | 1.0 |
| | M8340 | – | ■ | 225 | 0.30 | 3.0 | ■ | 135 | 0.27 | 3.0 | ✓ | 210 | 0.30 | 3.0 | – | – | – | – | 55 | 0.24 | 2.4 | – | – | – | |
| | M9325 | – | ■ | 295 | 0.30 | 3.0 | – | – | – | – | ■ | 280 | 0.30 | 3.0 | – | – | – | – | – | – | – | ■ | 55 | 0.21 | 1.0 |
| | M9340 | – | ■ | 265 | 0.30 | 3.0 | ■ | 155 | 0.27 | 3.0 | – | – | – | – | – | – | – | ■ | 65 | 0.24 | 2.4 | – | – | – | |

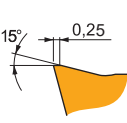

La geometria robusta R è utilizzata per la sgrossatura e condizioni di lavoro pesanti. Progettata con un angolo di taglio leggermente positivo, T-land ampio e arrotondamento del tagliente per lavorazioni di sgrossatura.

| | | | | | | | | | | | | | | | | | | | | | | | | |
|------------------------|--------------|---|---|-----|------|-----|---|-----|------|-----|-----|------|------|-----|---|---|---|---|---|---|---|----|------|-----|
| SDMT 13T3AFSN-R | M5315 | – | ✓ | 285 | 0.35 | 3.0 | – | – | – | ■ | 270 | 0.35 | 3.0 | – | – | – | – | – | – | – | ■ | 55 | 0.25 | 1.0 |
| | M8310 | – | ■ | 255 | 0.35 | 3.0 | ✓ | 130 | 0.32 | 3.0 | ■ | 240 | 0.35 | 3.0 | – | – | – | – | – | – | ■ | 50 | 0.25 | 1.0 |
| | M8330 | – | ■ | 240 | 0.35 | 3.0 | ✓ | 140 | 0.32 | 3.0 | ■ | 225 | 0.35 | 3.0 | – | – | – | – | – | – | ✓ | 45 | 0.25 | 1.0 |
| | M8340 | – | ■ | 220 | 0.35 | 3.0 | ✓ | 130 | 0.32 | 3.0 | ✓ | 205 | 0.35 | 3.0 | – | – | – | – | – | – | – | – | – | – |
| | M9325 | – | ■ | 280 | 0.35 | 3.0 | – | – | – | – | ■ | 265 | 0.35 | 3.0 | – | – | – | – | – | – | ■ | 55 | 0.25 | 1.0 |

XDET 13

PRAMET

| | IC | D1 | S |
|------|--------|------|------|
| | (mm) | (mm) | (mm) |
| 13T3 | 13.385 | 4.40 | 3.97 |

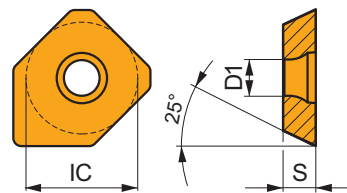

Idoneità e valori iniziali per velocità di taglio (Vc), avanzamento (f) e profondità di taglio (ap). Fare riferimento alla nostra App Machining Calculator per ulteriori calcoli.

| Prodotto | RE | P | | | M | | | K | | | N | | | S | | | H | | |
|----------|------|---------|------------|------|---------|------------|------|---------|------------|------|---------|------------|------|---------|------------|------|---------|------------|------|
| | | vc | f | ap | vc | f | ap | vc | f | ap | vc | f | ap | vc | f | ap | vc | f | ap |
| | (mm) | (m/min) | (mm/tooth) | (mm) | (m/min) | (mm/tooth) | (mm) | (m/min) | (mm/tooth) | (mm) | (m/min) | (mm/tooth) | (mm) | (m/min) | (mm/tooth) | (mm) | (m/min) | (mm/tooth) | (mm) |

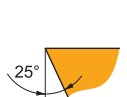

Design del raschiante volto a garantire una migliore finitura superficiale durante la lavorazione con frese di grandi dimensioni e in presenza di un avanzamento elevato.

| | | | | | | | | | | | | | | | | | | | | | | | | |
|----------------------|--------------|---|---|-----|------|-----|---|-----|------|-----|---|-----|------|-----|---|---|---|---|---|---|---|---|---|---|
| XDET 13T3AFER | 8215 | – | ■ | 420 | 0.10 | 0.2 | ✓ | 250 | 0.09 | 0.2 | ■ | 395 | 0.10 | 0.2 | – | – | – | – | – | – | – | – | – | – |
| | M8330 | – | ■ | 395 | 0.10 | 0.2 | ✓ | 235 | 0.09 | 0.2 | ■ | 375 | 0.10 | 0.2 | – | – | – | – | – | – | – | – | – | – |



| a_s / DC | 5% | 10% | 15% | 20% | 25% | 30% | 40% | 50% | 60% | 70% | 75% | 80% | 90% | 100% |
|------------|------|------|------|------|------|------|------|------|------|------|------|------|------|------|
| | 1.48 | 1.35 | 1.27 | 1.22 | 1.19 | 1.16 | 1.11 | 1.08 | 1.05 | 1.03 | 1.00 | 1.00 | 1.00 | 1.00 |
| | 2.20 | 1.60 | 1.35 | 1.20 | 1.10 | 0.95 | 0.85 | 0.75 | 0.85 | 0.95 | 1.00 | 1.00 | 1.00 | 1.00 |
| | 0.64 | 0.64 | 0.64 | 0.64 | 0.64 | 0.65 | 0.65 | 0.67 | 0.68 | 0.71 | 0.72 | 0.74 | 0.79 | 1.00 |

| | SDET 13-F | SDMT 13-M | SDMT 13-R | SDET 13-FA | XDET 13 |
|--|-----------|-----------|-----------|------------|---------|
| | - | - | - | - | - |
| | 1.75 | 1.75 | 1.75 | 1.75 | 8.19 |

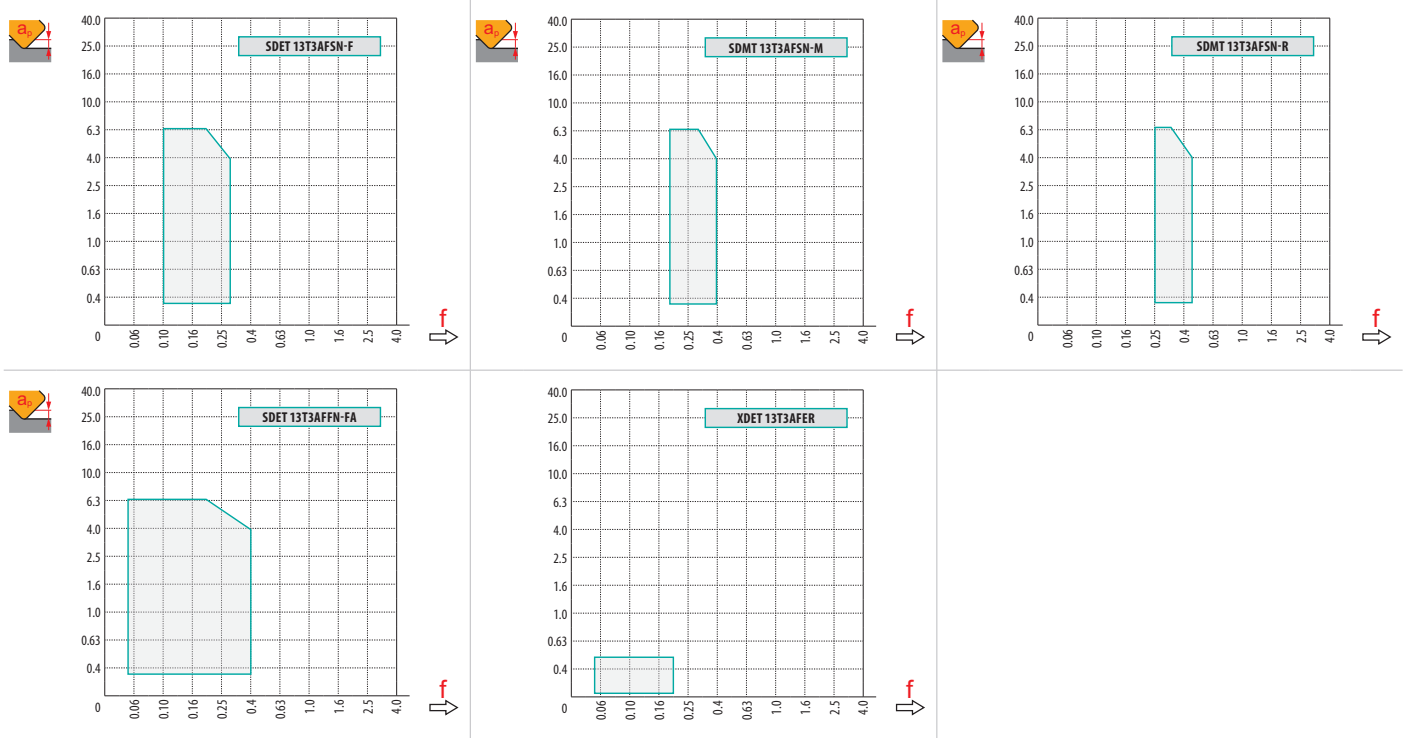

| | | | f_{max} | | | RPMX | APMX/I | | | DMIN | DMAX | | | |
|--|-----|------|-----------|--|-----|-------|----------|--|-----|-------|-------|-----|-----|-----|
| | 32 | 1.22 | 0.15 | | 32 | 14.1° | 6.4/27 | | 32 | 60.0 | 89.8 | 1.7 | 1.7 | 1.5 |
| | 40 | 1.26 | 0.16 | | 40 | 11.8° | 6.4/32 | | 40 | 75.0 | 107.0 | 1.7 | 1.7 | |
| | 50 | 1.30 | 0.18 | | 50 | 9.8° | 6.4/39 | | 50 | 94.0 | 127.0 | 1.7 | 1.7 | |
| | 63 | 1.34 | 0.20 | | 63 | 7.7° | 6.4/49 | | 63 | 120.0 | 152.8 | 1.7 | 1.7 | |
| | 80 | 1.39 | 0.22 | | 80 | 5.2° | 6.4/72 | | 80 | 155.0 | 186.8 | 1.7 | 1.7 | |
| | 100 | 1.43 | 0.24 | | 100 | 4.1° | 6.4/91 | | 100 | 193.0 | 225.8 | 1.7 | 1.7 | |
| | 125 | 1.48 | 0.26 | | 125 | 3.2° | 5.45/100 | | 125 | 245.0 | 275.6 | 1.7 | 1.7 | |
| | 160 | 1.53 | 0.29 | | 160 | 1.0° | 1.6/100 | | 160 | 322.0 | 345.6 | 1.7 | 1.7 | |
| | 200 | 1.58 | 0.33 | | 200 | 0.4° | 0.55/100 | | 200 | 405.0 | 425.6 | 1.7 | 1.7 | |
| | 250 | 1.63 | 0.36 | | 250 | 0.3° | 0.4/100 | | 250 | 505.0 | 525.6 | 1.7 | 1.7 | |



SLN12X

FRESA A SPALLAMENTO TANGENZIALE PRODUTTIVA

INTRODUZIONE



Un nuovo assortimento di inserti tangenziali negativi LNEX 12, con quattro taglienti, offre un'elevata soluzione produttiva per un'ampia gamma di applicazioni. L'inserto Pramet LNEX 12 è stato progettato per la fresatura di spallamenti retti, con una profondità di taglio massima fino a 10 mm, tagliente robusto e bloccaggio molto stabile. Il corpo fresa robusto garantisce una lunga durata dell'utensile e un'eccellente resistenza alla rottura, riducendo anche le vibrazioni.



LNEX-F

- Inserto produttivo a 4 taglienti rettificato
- Acciaio a basso contenuto di carbonio, acciaio inox tenero
- Taglio leggero e medio



LNEX-M

- Inserto produttivo a 4 taglienti rettificato
- Acciaio e ghisa, possibile anche acciaio duro
- Taglio medio e pesante

CARATTERISTICHE E VANTAGGI DEGLI INSERTI

Inserto robusto a quattro taglienti con geometria M ed F.



SOLUZIONE PRODUTTIVA

per un'ampia gamma di applicazioni, con maggiore avanzamento per dente e profondità di taglio.

Inserto tangenziale robusto con angolo di spoglia positivo per basse forze di taglio.



AZIONE DI TAGLIO REGOLARE,

ridotto carico del mandrino, eccellente evacuazione del truciolo e stabilità del processo.

Inserto rettificato per uno spallamento retto preciso.



ANGOLO DI 90° EFFETTIVO

con una migliore rettilineità e precisione della parete.

Geometria del tagliente del raggio brevettata per un'eccellente formazione e controllo del truciolo.



EVACUAZIONE TRUCIOLO MIGLIORATA

estende l'applicazione anche a macchine con poca potenza e profondità di taglio bassa.

Ampia gamma di applicazioni, con la possibilità di eseguire rampa, interpolazione elicoidale e fresatura a tuffo.



VERSATILITÀ OPERATIVA

che offre una soluzione economica.

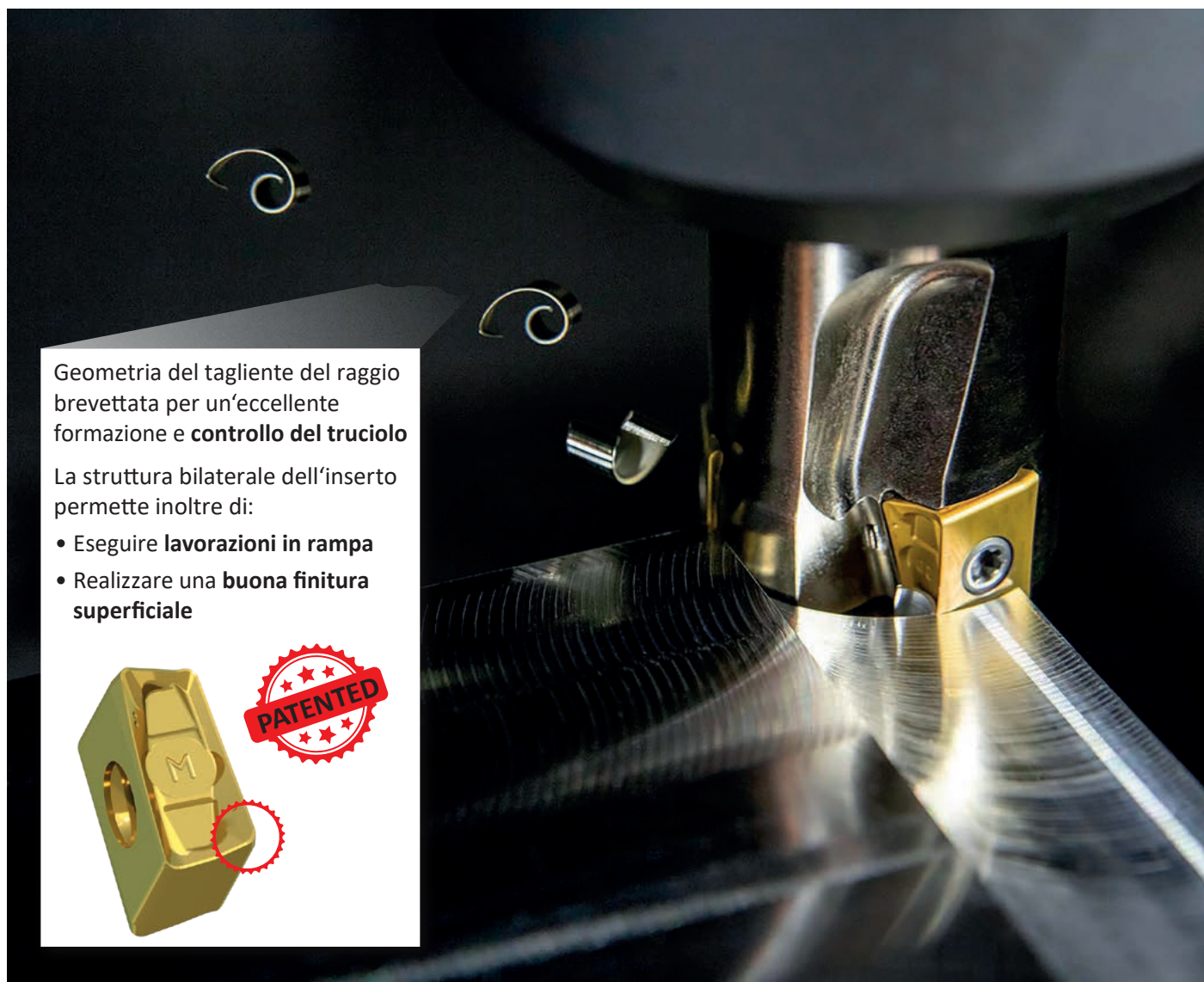

Geometria del tagliente del raggio brevettata per un'eccellente formazione e **controllo del truciolo**

La struttura bilaterale dell'inserto permette inoltre di:

- Eseguire **lavorazioni in rampa**
- Realizzare una **buona finitura superficiale**





SLN12X

FRESA A SPALLAMENTO TANGENZIALE PRODUTTIVA

CARATTERISTICHE E VANTAGGI DEI CORPI FRESA SLN12X

Maggiore resistenza e rigidità del corpo grazie ad uno spessore maggiore del nucleo.



PROCESSO DI TAGLIO AFFIDABILE

con vibrazioni ridotte e lunga durata sia del corpo fresa che dell'inserto.

Grandi viti di bloccaggio facilmente accessibili.



FACILE MONTAGGIO

e sostituzione inserti



SLN12X

- Attacco cilindrico
- Gamma DC
25 – 40 mm
1.00 – 1.50 pollice



SLN12X

- Attacco weldon
- Gamma DC
25 – 40 mm
1.00 – 1.50 pollice



SLN12X

- Attacco a manicotto
- Gamma DC
40 – 125 mm
1.50 – 5.00 pollice



ESEMPI DI FRESATURA A SPALLAMENTO

Particolare: Cerniera in acciaio strutturale forgiato (220 HB)
 Materiale: 1.0553 / 345A / S355JO
 Fresa: 50A05R-S90LN12X-C
 Refrigerante: Emulsione all'~ 8%

| Dati di taglio | | | | |
|-----------------------|------------|----------------|------------|----------|
| v_c (m/min) | f_z (mm) | a_p (mm) | a_e (mm) | TOH (mm) |
| 212 | 0.09 | 7 | 30 | 58 |
| Inserto | | Durata (pezzi) | | |
| LNEX 121008SR-F:M8340 | | 2200 | | |

La geometria F è molto performante, con il minor assorbimento potenza.
 Finitura superficiale perfetta, migliore di tutti i concorrenti.
 Usura del tagliante regolare, usura sul fianco molto omogenea.
 Nessuna formazione di bavco per tutta la durata dell'utensile => possibilità di salare una successiva operazione di sbavatura.



WMG P2.1

Particolare: Piastra in acciaio al Carbonio (220 HB)
 Materiale: 1.1186 / 1040 / C40
 Fresa: 50A05R-S90LN12X-C
 Refrigerante: No

| Dati di taglio | | | | |
|-----------------------|------------|--------------|------------|----------|
| v_c (m/min) | f_z (mm) | a_p (mm) | a_e (mm) | TOH (mm) |
| 113 | 0.18 | 5 | 3.5 | 138 |
| 118 | 0.28 | 3 | 30 | 84 |
| Inserto | | Durata (min) | | |
| LNEX 121008SR-F:M8340 | | 48+ | | |

Eccellente qualità superficiale nelle operazioni di sgrossatura e contornatura.
 Buona precisione della parete a 90° anche con sbalzo di 138 mm.
 Nessuna vibrazione con sporgenza di 85 mm e $f_z = 0.28$ mm.
 Evacuazione trucioli perfetta. Dopo 48 minuti nessuna usura evidente.

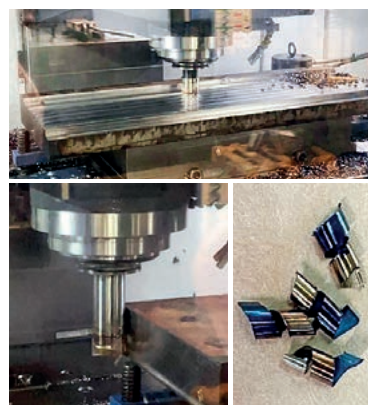

WMG P2.2

Particolare: Giunto in acciaio al Carbonio forgiato (~ 210 HB)
 Materiale: EN8D / 1045 / CK45
 Fresa: 32A3R042B32-SLN12X-C
 Refrigerante: Emulsione all'~ 6%

| Dati di taglio | | | | |
|-----------------------|------------|----------------|------------|----------|
| v_c (m/min) | f_z (mm) | a_p (mm) | a_e (mm) | TOH (mm) |
| 221 | 0.23 | 10 | 10 | 61 |
| Inserto | | Durata (pezzi) | | |
| LNEX 121008SR-M:M8310 | | 127 | | |

La riduzione del tempo di ciclo con LNEX 12-M è del 48%.
 Il miglioramento della durata dell'utensile con LNEX 12-M è del 59%.
 Osserviamo solo una leggera usura dopo 18 minuti di taglio.



WMG P2.3

Particolare: Valvola a 3 vie in acciaio inox forgiato (~ 190 HB)
 Materiale: 1.4401 / 316 / X5CrNiMo17-12-2
 Fresa: 25A2R042B25-SLN12X-C
 Refrigerante: No

| Dati di taglio | | | | |
|-----------------------|------------|--------------|------------|----------|
| v_c (m/min) | f_z (mm) | a_p (mm) | a_e (mm) | TOH (mm) |
| 100 | 0.2 | 3 | 6 | 45 |
| Inserto | | Durata (min) | | |
| LNEX 121008SR-F:M8340 | | 82 | | |

La riduzione del tempo di ciclo con LNEX 12-F è del 20%.
 Il miglioramento della durata dell'utensile con LNEX 12-F è del 50%.
 Osserviamo solo una leggera usura sul fianco dopo 16 minuti di taglio.



WMG M3.1



SLN12X



PRAMET

S



PROD LN12 Fresa tangenziale a spallamento retto a 90° con passaggio refrigerante interno

Frese a spallamento a 90° altamente produttive, che prevedono l'utilizzo dell'inserto tangenziale LNEXT 12 con 4 taglienti e un APMX di 10 mm. Adatte per una vasta gamma di applicazioni. Disponibilità di corpi fresa con attacco cilindrico, weldon e a manicotto. Il robusto corpo fresa garantisce una lunga vita utensile e un'eccellente resistenza alla rottura.

| | |
|------|---------|
| KAPR | 90° |
| APMX | 10.0 mm |

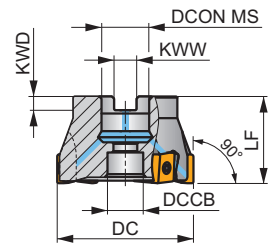
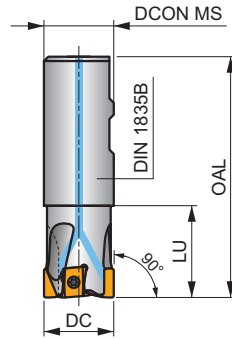
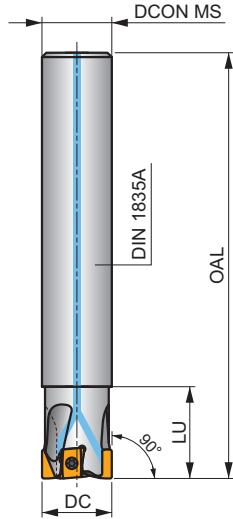
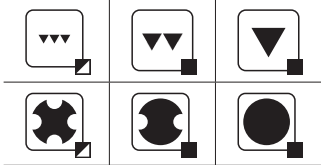
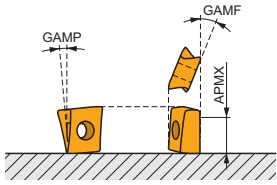

| | |
|--|----------------|
| | 0.06 – 0.20 mm |
| | 0.06 – 0.18 mm |



| Prodotto | DC (mm) | OAL (mm) | DCON MS (mm) | DCCB (mm) | LU (mm) | LF (mm) | KWW (mm) | KWD (mm) | GAMF (°) | GAMP (°) | | | | | | | | |
|----------------------|------------|-------------|-----------------|--------------|------------|------------|-------------|-------------|-------------|-------------|----|---|-------|---|------|-------|-------|--|
| 25A2R042A25-SLN12X-C | 25 | 170 | 25 | - | 42 | - | - | - | -30 | -5 | 2 | - | 17300 | ✓ | 0.55 | GI206 | C0382 | |
| 25A2R080A25-SLN12X-C | 25 | 170 | 25 | - | 80 | - | - | - | -30 | -5 | 2 | - | 17300 | ✓ | 0.50 | GI206 | C0382 | |
| 32A3R042A32-SLN12X-C | 32 | 195 | 32 | - | 42 | - | - | - | -22.5 | -5 | 3 | - | 15300 | ✓ | 1.01 | GI206 | SQ340 | |
| 32A3R090A32-SLN12X-C | 32 | 195 | 32 | - | 90 | - | - | - | -22.5 | -5 | 3 | - | 15300 | ✓ | 0.99 | GI206 | SQ340 | |
| 40A4R050A32-SLN12X-C | 40 | 195 | 32 | - | 50 | - | - | - | -22.5 | -5 | 4 | - | 13700 | ✓ | 1.17 | GI206 | SQ340 | |
| 25A2R042B25-SLN12X-C | 25 | 100 | 25 | - | 42 | - | - | - | -30 | -5 | 2 | - | 17300 | ✓ | 0.29 | GI206 | C0382 | |
| 32A3R042B32-SLN12X-C | 32 | 110 | 32 | - | 42 | - | - | - | -22.5 | -5 | 3 | - | 15300 | ✓ | 0.55 | GI206 | SQ340 | |
| 40A4R050B32-SLN12X-C | 40 | 120 | 32 | - | 50 | - | - | - | -22.5 | -5 | 4 | - | 13700 | ✓ | 0.73 | GI206 | SQ340 | |
| 40A03R-S90LN12X-C | 40 | - | 16 | 12.4 | - | 40 | 8.4 | 5.6 | -22.5 | -5 | 3 | - | 13700 | ✓ | 0.15 | GI206 | SQ345 | |
| 40A04R-S90LN12X-C | 40 | - | 16 | 12.4 | - | 40 | 8.4 | 5.6 | -22.5 | -5 | 4 | ✓ | 13700 | ✓ | 0.23 | GI206 | SQ345 | |
| 50A05R-S90LN12X-C | 50 | - | 22 | 16.5 | - | 40 | 10.4 | 6.3 | -19.5 | -5 | 5 | - | 12300 | ✓ | 0.34 | GI206 | SQ343 | |
| 50A06R-S90LN12X-C | 50 | - | 22 | 16.5 | - | 40 | 10.4 | 6.3 | -19.5 | -5 | 6 | - | 12300 | ✓ | 0.34 | GI206 | SQ343 | |
| 52A05R-S90LN12X-C | 52 | - | 22 | 16.5 | - | 40 | 10.4 | 6.3 | -19.5 | -5 | 5 | - | 12300 | ✓ | 0.37 | GI206 | SQ343 | |
| 63A06R-S90LN12X-C | 63 | - | 22 | 16.5 | - | 40 | 10.4 | 6.3 | -19.5 | -5 | 6 | ✓ | 10900 | ✓ | 0.52 | GI206 | SQ343 | |
| 63A08R-S90LN12X-C | 63 | - | 22 | 16.5 | - | 40 | 10.4 | 6.3 | -19.5 | -5 | 8 | - | 10900 | ✓ | 0.50 | GI206 | SQ343 | |
| 66A06R-S90LN12X-C | 66 | - | 22 | 16.5 | - | 40 | 10.4 | 6.3 | -19.5 | -5 | 6 | ✓ | 10900 | ✓ | 0.54 | GI206 | SQ343 | |
| 80A07R-S90LN12X-C | 80 | - | 27 | 38.1 | - | 50 | 12.4 | 7 | -19.5 | -5 | 7 | ✓ | 9700 | ✓ | 1.00 | GI206 | SQ341 | |
| 80A10R-S90LN12X-C | 80 | - | 27 | 38.1 | - | 50 | 12.4 | 7 | -19.5 | -5 | 10 | - | 9700 | ✓ | 0.98 | GI206 | SQ341 | |
| 100A08R-S90LN12X-C | 100 | - | 32 | 45.1 | - | 50 | 14.4 | 8 | -17.5 | -5 | 8 | ✓ | 8700 | ✓ | 1.91 | GI206 | SQ341 | |
| 100A11R-S90LN12X-C | 100 | - | 32 | 45.1 | - | 50 | 14.4 | 8 | -17.5 | -5 | 11 | - | 8700 | ✓ | 1.88 | GI206 | SQ341 | |
| 125A12R-S90LN12X-C | 125 | - | 40 | 56.1 | - | 63 | 16.4 | 9 | -17.5 | -5 | 12 | ✓ | 7800 | ✓ | 3.39 | GI206 | SQ341 | |

GI206 LNEX 1210..



| C0382 | US 44010-T15P | 3.5 | M 4 | 10 | - | - | Flag T15P | - | - |
|-------|---------------|-----|-----|----|-------------|-------|-----------|----------|---|
| SQ340 | US 44012-T15P | 3.5 | M 4 | 12 | - | - | Flag T15P | - | - |
| SQ341 | US 44012-T15P | 3.5 | M 4 | 12 | D-T08P/T15P | FG-15 | - | - | - |
| SQ343 | US 44012-T15P | 3.5 | M 4 | 12 | D-T08P/T15P | FG-15 | - | HS 1030C | - |
| SQ345 | US 44012-T15P | 3.5 | M 4 | 12 | D-T08P/T15P | FG-15 | - | HS 90835 | - |

LNEX 12



| | W1 | D1 | L | S |
|------|-------|------|-------|-------|
| | (mm) | (mm) | (mm) | (mm) |
| 1210 | 6.000 | 4.40 | 13.30 | 10.26 |

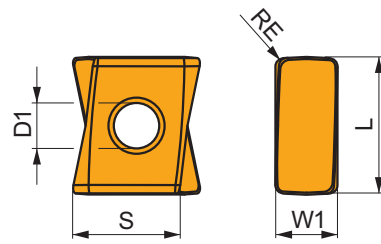

Idoneità e valori iniziali per velocità di taglio (Vc), avanzamento (f) e profondità di taglio (ap). Fare riferimento alla nostra App Machining Calculator per ulteriori calcoli.

| Prodotto | RE | P | | | M | | | K | | | N | | | S | | | H | | |
|----------|------|---------|------------|------|---------|------------|------|---------|------------|------|---------|------------|------|---------|------------|------|---------|------------|------|
| | | vc | f | ap | vc | f | ap | vc | f | ap | vc | f | ap | vc | f | ap | vc | f | ap |
| | (mm) | (m/min) | (mm/tooth) | (mm) | (m/min) | (mm/tooth) | (mm) | (m/min) | (mm/tooth) | (mm) | (m/min) | (mm/tooth) | (mm) | (m/min) | (mm/tooth) | (mm) | (m/min) | (mm/tooth) | (mm) |

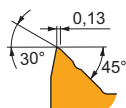

La geometria positiva F è utilizzata per lavorazioni leggere e medie, adatta per applicazioni caratterizzate da sbalzi elevati. Progettata con un angolo di taglio altamente positivo, T-land stretto e arrotondamento del tagliente per lavorazioni da leggere a medie.

| | | | | | | | | | | | | | | | | | | | |
|-----------------|-------|-----|-----|------|-----|-----|------|-----|-----|------|-----|---|---|---|---|---|----|------|-----|
| LNEX 121008SR-F | M6330 | 0.8 | 220 | 0.17 | 3.0 | 155 | 0.15 | 3.0 | - | - | - | - | - | - | - | - | - | - | - |
| | M8310 | 0.8 | 280 | 0.17 | 3.0 | 140 | 0.15 | 3.0 | 265 | 0.17 | 3.0 | - | - | - | - | - | 55 | 0.11 | 1.0 |
| | M8330 | 0.8 | 260 | 0.17 | 3.0 | 155 | 0.15 | 3.0 | 245 | 0.17 | 3.0 | - | - | - | - | - | 50 | 0.11 | 1.0 |
| LNEX 121012SR-F | M6330 | 1.2 | 230 | 0.17 | 3.0 | 165 | 0.15 | 3.0 | - | - | - | - | - | - | - | - | - | - | - |
| | M8310 | 1.2 | 295 | 0.17 | 3.0 | 150 | 0.15 | 3.0 | 280 | 0.17 | 3.0 | - | - | - | - | - | 55 | 0.11 | 1.0 |
| | M8330 | 1.2 | 270 | 0.17 | 3.0 | 160 | 0.15 | 3.0 | 255 | 0.17 | 3.0 | - | - | - | - | - | 50 | 0.11 | 1.0 |

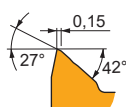

La geometria versatile M rappresenta la prima scelta per una vasta gamma di condizioni di lavoro. Progettata con un angolo di taglio positivo, T-land medio e arrotondamento del tagliente per lavorazioni da medie a semi-sgrossatura.

| | | | | | | | | | | | | | | | | | | | |
|-----------------|-------|-----|-----|------|-----|---|---|---|-----|------|-----|---|---|---|---|---|----|------|-----|
| LNEX 121008SR-M | M6330 | 0.8 | 210 | 0.20 | 3.5 | - | - | - | - | - | - | - | - | - | - | - | - | - | - |
| | M8310 | 0.8 | 265 | 0.20 | 3.5 | - | - | - | 250 | 0.20 | 3.5 | - | - | - | - | - | 50 | 0.16 | 1.0 |
| | M8330 | 0.8 | 245 | 0.20 | 3.5 | - | - | - | 230 | 0.20 | 3.5 | - | - | - | - | - | 45 | 0.16 | 1.0 |
| | M8340 | 0.8 | 220 | 0.20 | 3.5 | - | - | - | 205 | 0.20 | 3.5 | - | - | - | - | - | - | - | - |
| | M9315 | 0.8 | 320 | 0.20 | 3.5 | - | - | - | 300 | 0.20 | 3.5 | - | - | - | - | - | 60 | 0.16 | 1.0 |
| | M9325 | 0.8 | 300 | 0.20 | 3.5 | - | - | - | 285 | 0.20 | 3.5 | - | - | - | - | - | 60 | 0.16 | 1.0 |
| LNEX 121012SR-M | M9340 | 0.8 | 270 | 0.20 | 3.5 | - | - | - | - | - | - | - | - | - | - | - | - | - | - |
| | M8310 | 1.2 | 280 | 0.20 | 3.5 | - | - | - | 265 | 0.20 | 3.5 | - | - | - | - | - | 55 | 0.16 | 1.0 |
| | M8330 | 1.2 | 255 | 0.20 | 3.5 | - | - | - | 240 | 0.20 | 3.5 | - | - | - | - | - | 50 | 0.16 | 1.0 |
| LNEX 121016SR-M | M8340 | 1.2 | 235 | 0.20 | 3.5 | - | - | - | 220 | 0.20 | 3.5 | - | - | - | - | - | - | - | - |
| | M8310 | 1.6 | 295 | 0.20 | 3.5 | - | - | - | 280 | 0.20 | 3.5 | - | - | - | - | - | 55 | 0.16 | 1.0 |
| | M8330 | 1.6 | 270 | 0.20 | 3.5 | - | - | - | 255 | 0.20 | 3.5 | - | - | - | - | - | 50 | 0.16 | 1.0 |
| LNEX 121020SR-M | M8340 | 1.6 | 245 | 0.20 | 3.5 | - | - | - | 230 | 0.20 | 3.5 | - | - | - | - | - | - | - | - |
| | M8330 | 2.0 | 285 | 0.20 | 3.5 | - | - | - | 270 | 0.20 | 3.5 | - | - | - | - | - | 55 | 0.16 | 1.0 |
| | M8340 | 2.0 | 255 | 0.20 | 3.5 | - | - | - | 240 | 0.20 | 3.5 | - | - | - | - | - | - | - | - |
| LNEX 121024SR-M | M8330 | 2.4 | 285 | 0.20 | 3.5 | - | - | - | 270 | 0.20 | 3.5 | - | - | - | - | - | 55 | 0.16 | 1.0 |
| | M8340 | 2.4 | 255 | 0.20 | 3.5 | - | - | - | 240 | 0.20 | 3.5 | - | - | - | - | - | - | - | - |



| a_e / DC | 5 % | 10 % | 15 % | 20 % | 25 % | 30 % | 40 % | 50 % | 60 % | 70 % | 75 % | 80 % | 90 % | 100 % |
|------------|------|------|------|------|------|------|------|------|------|------|------|------|------|-------|
| | 1.48 | 1.35 | 1.27 | 1.22 | 1.19 | 1.16 | 1.11 | 1.08 | 1.05 | 1.03 | 1.00 | 1.00 | 1.00 | 1.00 |
| | 2.20 | 1.60 | 1.35 | 1.20 | 1.10 | 0.95 | 0.85 | 0.75 | 0.85 | 0.95 | 1.00 | 1.00 | 1.00 | 1.00 |
| | 0.64 | 0.64 | 0.64 | 0.64 | 0.64 | 0.65 | 0.65 | 0.67 | 0.68 | 0.71 | 0.72 | 0.74 | 0.79 | 1.00 |

| | LNEX 12-F | | LNEX 12-M | | | | |
|--|-----------|------|-----------|------|------|------|------|
| | 0.8 | 1.2 | 0.8 | 1.2 | 1.6 | 2.0 | 2.4 |
| | 2.25 | 1.73 | 2.25 | 1.73 | 1.33 | 1.15 | 0.79 |

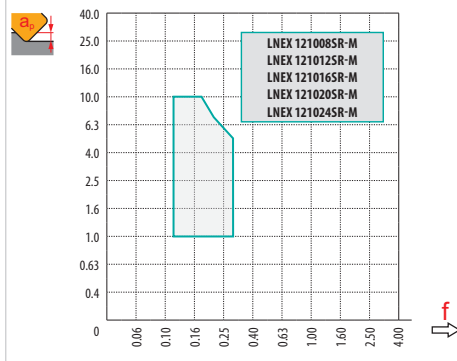
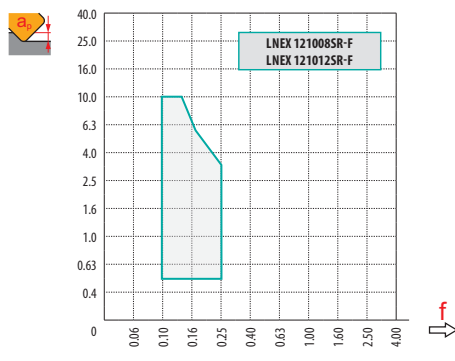

| | |
|--|-----|
| | |
| | 2.5 |

| | | | | |
|--|------|------|------|------|
| | | | | |
| | 2.0 | 3.0 | 4.0 | 5.0 |
| | 0.30 | 0.20 | 0.20 | 0.15 |

| | RPMX | APMX/I |
|----|-------|----------|
| 25 | 0.80° | 1.40/100 |
| 32 | 0.60° | 1.00/100 |
| 40 | 0.35° | 0.60/100 |
| 50 | 0.30° | 0.50/100 |
| 52 | 0.30° | 0.50/100 |
| 63 | 0.20° | 0.35/100 |

| | DMIN | DMAX | | |
|----|-------|-------|-----|-----|
| 25 | 44.0 | 48.0 | 0.6 | 0.7 |
| 32 | 58.0 | 62.0 | 0.8 | 1.0 |
| 40 | 74.0 | 78.0 | 0.7 | 0.8 |
| 50 | 94.0 | 98.0 | 0.7 | 0.8 |
| 52 | 98.0 | 102.0 | 0.7 | 0.8 |
| 63 | 120.0 | 124.0 | 0.3 | 0.4 |



| DC | μm | 3 | 5 | 10 | 15 | 20 | 30 | 40 | 50 | 60 | 80 | 100 |
|----|---------------|-------|-------|-------|-------|-------|-------|-------|-------|-------|-------|-------|
| 25 | | 0.548 | 0.707 | 1.000 | 1.225 | 1.414 | 1.732 | 2.000 | 2.236 | 2.449 | 2.828 | 3.162 |
| 32 | | 0.620 | 0.800 | 1.131 | 1.386 | 1.600 | 1.960 | 2.263 | 2.530 | 2.771 | 3.200 | 3.578 |
| 40 | | 0.693 | 0.894 | 1.265 | 1.549 | 1.789 | 2.191 | 2.530 | 2.828 | 3.098 | 3.578 | 4.000 |
| 50 | | 0.775 | 1.000 | 1.414 | 1.732 | 2.000 | 2.449 | 2.828 | 3.162 | 3.464 | 4.000 | 4.472 |
| 52 | | 0.869 | 1.122 | 1.587 | 1.944 | 2.245 | 2.750 | 3.175 | 3.550 | 3.888 | 4.490 | 5.020 |
| 63 | | 0.980 | 1.265 | 1.789 | 2.191 | 2.530 | 3.098 | 3.578 | 4.000 | 4.382 | 5.060 | 5.657 |

| RE | μm | 3 | 5 | 10 | 15 | 20 | 30 | 40 | 50 | 60 | 80 | 100 |
|-----|---------------|-------|-------|-------|-------|-------|-------|-------|-------|-------|-------|-------|
| 0.8 | | 0.155 | 0.200 | 0.283 | 0.346 | 0.400 | 0.490 | 0.566 | 0.632 | 0.693 | 0.800 | 0.894 |
| 1.2 | | 0.170 | 0.219 | 0.310 | 0.379 | 0.438 | 0.537 | 0.620 | 0.693 | 0.759 | 0.876 | 0.980 |
| 1.6 | | 0.196 | 0.253 | 0.358 | 0.438 | 0.506 | 0.620 | 0.716 | 0.800 | 0.876 | 1.012 | 1.131 |
| 2.0 | | 0.219 | 0.283 | 0.400 | 0.490 | 0.566 | 0.693 | 0.800 | 0.894 | 0.980 | 1.131 | 1.265 |
| 2.4 | | 0.245 | 0.316 | 0.447 | 0.548 | 0.632 | 0.775 | 0.894 | 1.000 | 1.095 | 1.265 | 1.414 |





SNGX 11

GEOMETRIA ROBUSTA PER ALTO AVANZAMENTO – HM

INTRODUZIONE



È stata introdotta una nuova geometria robusta HM per supportare le attuali frese ad alto avanzamento SSN11 ed i relativi inserti SNGX 11. La geometria è specifica per la lavorazione di acciaio duro/temprato e ghisa. È l'ultima aggiunta agli inserti bilaterali SNGX altamente produttivi con otto taglienti.

 **PRAMET**

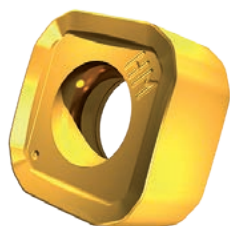

SNGX-HM

- Insetto ad alto avanzamento a 8 taglienti
- Acciaio duro, ghisa
- Taglio medio e sgrossatura



CARATTERISTICHE E VANTAGGI

Geometria robusta più idonea per determinati materiali.



Estende il campo di applicazione della famiglia di frese SSN11
NEGLI ACCIAI DURI/TEMPRATI E NELLE GHISE.

Il rinforzo T-land altamente negativo fornisce maggior robustezza al tagliente.



MAGGIORE DURATA E SICUREZZA
del processo di fresatura, prolungamento della durata utensile, fino al 50 % , rispetto alle precedenti geometrie inserto.

Rinforzo T-land stretto ed angolo positivo del tagliente per forze di taglio ridotte.



Carico mandrino inferiore, vibrazioni ridotte e maggiore scorrevolezza nell'azione di taglio,
MIGLIORANDO LA STABILITÀ DEL PROCESSO.

Rapporto equilibrato tra affilatura e rinforzo del tagliente.



Consente una nuova opzione per la fresatura ad alto avanzamento dei materiali duri/temprati su macchine
CON COPPIA E RIGIDITÀ INFERIORI.

ESEMPI DI FRESATURA A SPIANARE AD ALTO AVANZAMENTO

Particolare: Stampo in acciaio (310 HB)
Materiale: 1.2343 / H11 / SKD6
Fresa: 50A05R-SMOSN11-C
Refrigerante: No

| Dati di taglio | | | | |
|----------------|------------|--------------|------------|----------|
| v_c (m/min) | f_z (mm) | a_p (mm) | a_e (mm) | TOH (mm) |
| 150 | 1.2 | 1.5 | 33 | 62 |
| Inserto | | Durata (min) | | |
| SNGX 110416SR- | | M:M8310 | 78 | |
| | | HM:M8310 | 105 | |

SNGX 110416SR-HM:M8310, 105 min

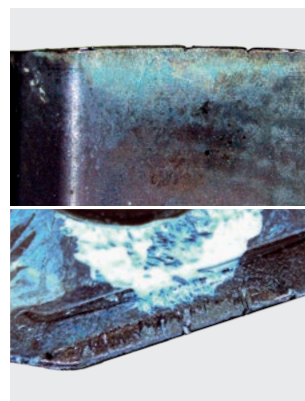

WMG P4.2

Particolare: Piastra in ghisa (210 HB)
Materiale: GG25 / FC250
Fresa: 50A05R-SMOSN11-C
Refrigerante: No

| Dati di taglio | | | | |
|----------------|------------|--------------|------------|----------|
| v_c (m/min) | f_z (mm) | a_p (mm) | a_e (mm) | TOH (mm) |
| 180 | 1 | 1 | 33 | 62 |
| Inserto | | Durata (min) | | |
| SNGX 110416SR- | | M:M8330 | 27 | |
| | | HM:M8330 | 42 | |

SNGX 110416SR-HM:M8330, 42 min

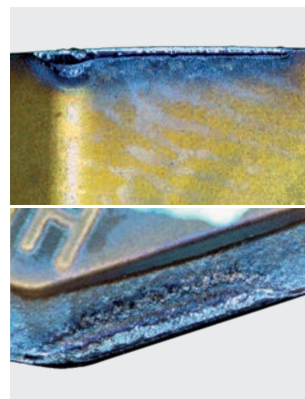

WMG K1.2



SBN10

FRESE A MANICOTTO AGGIUNTIVE

INTRODUZIONE



Diverse nuove frese a manicotto sono state aggiunte alla gamma di fresatura ad alto avanzamento SBN10. L'ultimo aggiornamento include diametri fresa a partire da 50 fino a 66 mm con due varianti di passo dei denti. Tutte le nuove frese hanno diversi angoli di impostazione della sede dell'inserto, con conseguente evacuazione del truciolo ideale quando si utilizzano inserti BNGX 10 per la fresatura HFC produttiva.

 PRAMET



SBN10

- Attacco a manicotto
- Nuova gamma DC:
40 – 66 mm
1.50 – 2.00 pollici



FRESE A MANICOTTO SBN10 – CARATTERISTICHE E VANTAGGI

Corpo fresa in acciaio da utensili ad alta qualità, nichelato.



GRANDE DURATA

dei corpi fresa induriti.

Angoli fresa diversi sui nuovi corpi a manicotto per prevenire l'incollamento dei trucioli.



LUNGA VITA UTENSILE

grazie all'evacuazione trucioli ottimizzata.

Frese a manicotto disponibili in diametri maggiori e vari tipi di passo dei denti.



GAMMA COMPETITIVA

delle frese SBN10 per ogni utilizzo.

Nuovi angoli fresa evitano l'incollamento dei trucioli

Nuovi corpi fresa con angolo di taglio $KAPR = 29^\circ$ sono compatibili con gli inserti BNGX 10 ma non con ANHX 10.

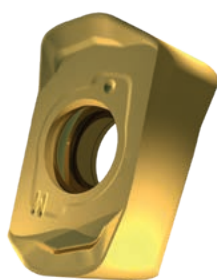

BNGX-M

- Inserto HFC a 4 taglienti
- Acciaio, ghisa
- Taglio medio



BNGX-MM

- Inserto HFC a 4 taglienti
- Acciaio inox, HRSA
- Taglio leggero



BNGX-HM

- Inserto HFC a 4 taglienti
- Ghisa, acciaio duro
- Taglio pesante

**SWN04C****FRESE AD ALTA PRECISIONE RINNOVATE****INTRODUZIONE**

Un'importante modifica di tutti i corpi fresa SWN04C. Queste frese modulari hanno un nuovo design di bloccaggio cilindro (DCON MS), che ha un cono pronunciato con una naturale capacità di auto-centraggio. Inoltre, tutte le frese SWN04C ora hanno un trattamento superficiale di colore nero che consente di ridurre le tolleranze di posizionamento e bloccaggio dell'insero. Entrambe le modifiche si traducono in un bloccaggio ad alta precisione e una ridotta eccentricità radiale, pur rimanendo compatibile con i comuni porta-frese modulari!

**SWN04C**

- Testina modulare
- Gamma DC: 16 – 35 mm

**SWN04C**

- Attacco cilindrico
- Gamma DC: 16 – 32 mm



FRESE MODULARI SWN04C – CARATTERISTICHE E VANTAGGI

Nuovo design di bloccaggio autocentrante, compatibile con i porta frese modulari utilizzati.



BLOCCAGGIO PRECISO

di tutti i corpi fresa modulari.

Trattamento superficiale di colore nero al posto della nichelatura consente tolleranze ancora più strette.



RUNOUT RADIALE MIGLIORATO

ridotto a pochi micron.

Corpo fresa in acciaio di alta qualità, con trattamento di colore nero.



ELEVATA DURATA

dei corpi fresa induriti.

Corpi fresa di colore nero per maggior precisione nelle sedi e nel montaggio.

Rettifica di precisione del bloccaggio conico autocentrante.

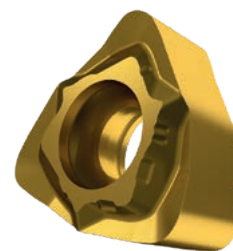

WNHX

- Inserto di finitura a 6 taglienti
- Acciai, acciai duri e ghise
- Finitura di pareti e superfici con lunga sporgenza



DORMER PRAMET



TUTTI GLI UTENSILI INSIEME

Il nostro intero assortimento di utensili integrali e a fissaggio meccanico è incluso nell'app per il calcolo dei parametri. Sono più di **40.000** articoli! Qualunque sia la vostra lavorazione, sicuramente sull'app ci sarà.

Semplicemente affidabili.

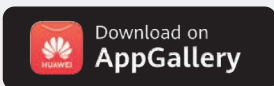
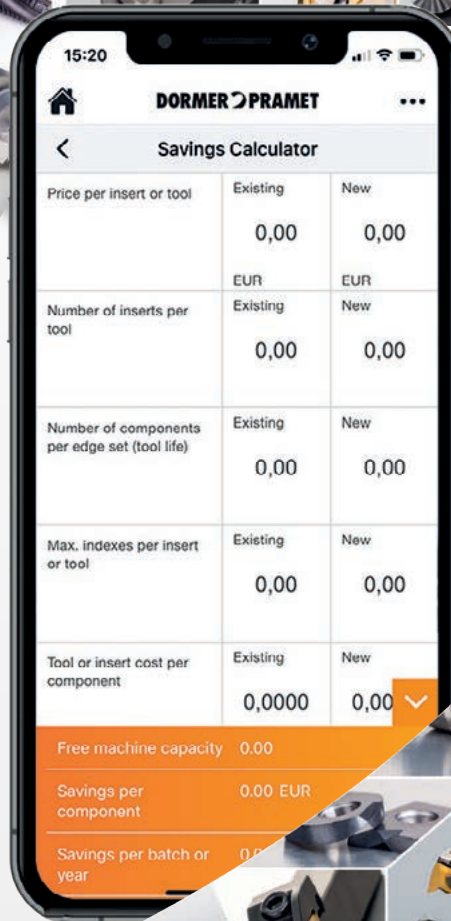











INFORMAZIONI TECNICHE



FATTORI DI CORREZIONE – TORNITURA

Fattori di correzione per tipo specifico di operazione C_{VCO}

|    |  | | |  | | |  | | |  | | |  | | |
|--|---|------|------|---|------|------|--|------|------|---|------|------|---|------|------|
| | 0.5 | | | 1.5 | | | 2.5 | | | 5.0 | | | 12.0 | | |
| | I | II | III | I | II | III | I | II | III | I | II | III | I | II | III |
| | 0.05 | 0.08 | 0.10 | 0.10 | 0.15 | 0.20 | 0.20 | 0.30 | 0.40 | 0.40 | 0.60 | 0.80 | 0.80 | 1.00 | 1.30 |
| Rompitruciolo per finitura (FF, FF2...) | 1.15 | 1.00 | 0.95 | 0.85 | 0.80 | – | – | – | – | – | – | – | – | – | – |
| Rompitruciolo per finitura (NF, SF...) | – | – | 1.20 | 1.05 | 1.00 | 1.05 | 1.00 | 0.90 | – | – | – | – | – | – | – |
| Rompitruciolo per lavorazione media (FM, M, NM, NMR, SM...) | – | – | – | – | – | 1.15 | 1.10 | 1.00 | 0.95 | 0.85 | – | – | – | – | – |
| Rompitruciolo per sgrossatura (RM, NRM, NR, R...) | – | – | – | – | – | – | – | – | 1.25 | 1.10 | 1.00 | 0.95 | 0.65 | – | – |
| Rompitruciolo per sgrossatura pesante (HR, HR2, NR2, OR...) per una durata di 45 min | – | – | – | – | – | – | – | – | – | 1.25 | 1.20 | 1.15 | 1.05 | 1.00 | 0.95 |

Fattori di correzione per durabilità richiesta C_{VCT}

|  | minuti | 10 | 15 | 20 | 30 | 45 | 60 |
|--|--------|------|------|------|------|------|------|
| Operazioni di lavorazione generica (da finitura fine a sgrossatura) | | 1.13 | 1.00 | 0.93 | 0.84 | 0.76 | 0.71 |
| Operazioni di lavorazione pesante (sgrossatura pesante) | | – | – | – | 1.10 | 1.00 | 0.93 |

Fattori di correzione aggiuntivi C_{VCA}

| Ambiente di lavorazione | C_{VCA} |
|--|-----------|
| Condizione del materiale da lavorare (crosta dura dovuta a forgiatura o fusione) | 0.70 |
| Tornitura interna | 0.75 |
| Troncatura e scanalatura (radiale) | 0.88 |
| Scanalatura frontale | 0.80 |
| Taglio interrotto | 0.80 |
| Condizioni di lavorazione instabili | 0.85 |
| Condizioni di lavorazione comuni | 1.00 |
| Condizioni di lavorazione stabili | 1.20 |

Velocità di taglio corretta risultante v_{CC}

$$v_{CC} = v_c \times k_{VG} \times C_{VCO} \times C_{VCT} \times C_{VCA}$$





v_c – velocità iniziale dalla pagina del catalogo

k_{VG} – coefficiente del materiale usato



FATTORI DI CORREZIONE – FRESE AD INSERTI

Fattori di correzione per tipo specifico di fresa e operazione C_{VCO}

|  |  |  |  |
|--|---|---|---|
| Frese per spianatura con <i>KAPR 45° – 60°</i> e inserti negativi (SHN06C, SHN09C, CHN09, ...) | 1.15 | 1.00 | 0.85 |
| Frese per spianatura con <i>KAPR 45°</i> e inserti positivi (SOE06Z, SOE09Z, SOD05,...) | 1.15 | 1.00 | 0.85 |
| Frese per spallamento con <i>KAPR 90°</i> (SAD07D, SAD11E, SAD16E, SLN12, SLN16..) | 1.10 | 1.00 | 0.90 |
| Frese per spianatura a copiare (SRC10 – SRC20, SRD05 – SRD16, ...) | 1.10 | 1.00 | 0.90 |
| Frese a candela a copiare (K2-PPH, K2-SLC, K2-SRC, K3-CXP...) | 1.10 | 1.00 | 0.90 |
| Frese a disco (S90CN(XN), S90SN...) | 1.10 | 1.00 | 0.90 |
| Frese per spallamento con canalini J(T)-CSD12X, J(T)-SAD11E, J(T)-SAD16E...) | 1.25 | 1.00 | 0.80 |
| Frese per spianatura per utilizzo gravoso (FSB22X, SPN13..) | 1.30 | 1.00 | 0.85 |
| Frese per spallamento per utilizzo gravoso (FTB27X..) | 1.25 | 1.00 | 0.85 |

Fattori di correzione per durata richiesta C_{VCT}

|  | minuti | 15 | 20 | 30 | 45 | 60 | 90 | 120 |
|---|--------|------|------|------|------|------|------|------|
| Operazioni di lavorazione generica (da finitura fine a sgrossatura) | | 1.23 | 1.13 | 1.00 | 0.89 | 0.81 | 0.72 | – |
| Operazioni di lavorazione pesante (sgrossatura pesante) | | – | – | 1.23 | 1.13 | 1.00 | 0.89 | 0.81 |

Fattori di correzione aggiuntivi C_{VCA}

| Ambiente di lavorazione | C_{VCA} |
|--|-----------|
| Condizione del materiale da lavorare (crosta dura dovuta a forgiatura o fusione) | 0.70 |
| Condizioni di lavorazione instabili | 0.85 |
| Condizioni di lavorazione comuni | 1.00 |
| Condizioni di lavorazione stabili | 1.20 |

Fattori di correzione per velocità di taglio durante la fresatura di spianatura o di spallamento con immersione radiale < 100% C_{VCRCT}

| $\frac{a_p}{DC}$ | 5 % | 10 % | 15 % | 20 % | 25 % | 30 % | 40 % | 50 % | 60 % | 70 % | 75 % | 80 % | 90 % | 100 % |
|---|------|------|------|------|------|------|------|------|------|------|------|------|------|-------|
|  | 1.48 | 1.35 | 1.27 | 1.22 | 1.19 | 1.16 | 1.11 | 1.08 | 1.05 | 1.03 | 1.00 | 1.00 | 1.00 | 1.00 |

Velocità di taglio corretta risultante v_{CC}

$$v_{CC} = v_c \times k_{VG} \times C_{VCO} \times C_{VCT} \times C_{VCA} \times C_{fzRCT}$$

v_c – velocità iniziale dalla pagina del catalogo

k_{VG} – coefficiente del materiale usato



WMG (GRUPPI DEI MATERIALI LAVORATI)

| Gruppo ISO | WMG (Gruppi dei materiali lavorati) | Durezza (HB or HRC) | Massima resistenza alla trazione (MPa) | Correzione fattore kvG | | | | | |
|------------|-------------------------------------|---------------------|---|---|---|---------------|--------------|---------------|------|
| P | P1 | P1.1 | Solfurizzato | < 240 HB | ≤ 830 | 1.33 | | | |
| | | P1.2 | Acciaio ad alta velocità (acciaio al carbonio con aumentata lavorabilità) | Solfurizzato e fosfatizzato | < 180 HB | ≤ 620 | 1.49 | | |
| | | P1.3 | | Solfurizzato e fosfatizzato con piombo | < 180 HB | ≤ 620 | 1.53 | | |
| | P2 | P2 | P2.1 | Acciaio al carbonio (acciaio composto principalmente da ferro e carbonio) | Contenuto < 0.25 % C | < 180 HB | ≤ 620 | 1.14 | |
| | | | P2.2 | | Contenuto < 0.55 % C | < 240 HB | ≤ 830 | 1.00 | |
| | | | P2.3 | | Contenuto > 0.55 % C | < 300 HB | ≤ 1030 | 0.89 | |
| | P3 | P3 | P3.1 | Acciaio legato (acciaio al carbonio con contenuto di legante ≤ 10%) | Ricotto | < 180 HB | ≤ 620 | 0.92 | |
| | | | P3.2 | | Indurito e temprato | 180 – 260 HB | > 620 ≤ 900 | 0.74 | |
| | | | P3.3 | | | 260 – 360 HB | > 900 ≤ 1240 | 0.63 | |
| | P4 | P4 | P4.1 | Acciaio per utensili (acciaio non trattabile al cromo) | Ricotto | < 26 HRC | ≤ 900 | 0.55 | |
| P4.2 | | | | Indurito e temprato | 26 – 39 HRC | > 900 ≤ 1240 | 0.47 | | |
| P4.3 | | | | | 39 – 45 HRC | > 1240 ≤ 1450 | 0.38 | | |
| M | M1 | M1.1 | Acciaio inox ferritico (leghe al cromo non temprabili) | | < 160 HB | ≤ 520 | 1.22 | | |
| | | M1.2 | | | 160 – 220 HB | > 520 ≤ 700 | 1.03 | | |
| | M2 | M2 | M2.1 | Acciaio inox martensitico (acciaio al cromo da bonifica) | Ricotto | < 200 HB | ≤ 670 | 1.08 | |
| | | | M2.2 | | Temprato e rinvenuto | 200 – 280 HB | > 670 ≤ 950 | 0.89 | |
| | | | M2.3 | | Trattato per precipitazione | 280 – 380 HB | > 950 ≤ 1300 | 0.75 | |
| | M3 | M3 | M3.1 | Acciaio inox austenitico (leghe al cromo nickel e al cromo nickel manganese) | | < 200 HB | ≤ 750 | 1.00 | |
| | | | M3.2 | | | 200 – 260 HB | > 750 ≤ 870 | 0.86 | |
| | | | M3.3 | | | 260 – 300 HB | > 870 ≤ 1040 | 0.77 | |
| | M4 | M4 | M4.1 | Acciaio inox, austenitico-ferritico (DUPLEX) o super-austenitico | | < 300 HB | ≤ 990 | 0.75 | |
| | | | M4.2 | Acciaio inox austenitico, indurito per precipitazione | | 300 – 380 HB | ≤ 1320 | 0.64 | |
| K | K1 | K1.1 | Ghisa grigia (ASTM A48) o ghisa grigia per automotive (ASTM A159) (ghisa fusa con microstruttura a grafite lamellare) | Ferritica o ferritica-perlitica | < 180 HB | ≤ 190 | 1.35 | | |
| | | K1.2 | | Ferritica-perlitica o perlitica | 180 – 240 HB | > 190 ≤ 310 | 1.00 | | |
| | | K1.3 | | Perlitica | 240 – 280 HB | > 310 ≤ 390 | 0.75 | | |
| | K2 | K2 | K2.1 | Ghisa malleabile (ASTM A602) (ghisa fusa con microstruttura a grafite libera) | Ferritica | < 160 HB | ≤ 400 | 1.39 | |
| | | | K2.2 | | Ferritica o perlitica | 160 – 200 HB | > 400 ≤ 550 | 1.13 | |
| | | | K2.3 | | Perlitica | 200 – 240 HB | > 550 ≤ 660 | 0.90 | |
| | K3 | K3 | K3.1 | Ghisa malleabile (ASTM A536) (ghisa fusa con microstruttura a grafite nodulare) | Ferritica | < 180 HB | ≤ 560 | 1.23 | |
| | | | K3.2 | | Ferritica o perlitica | 180 – 220 HB | > 560 ≤ 680 | 0.94 | |
| | | | K3.3 | | Perlitica | 220 – 260 HB | > 680 ≤ 800 | 0.76 | |
| | K4 | K4 | K4.1 | Ghisa Grigia Austenitica (ASTM A436) (leghe di ghisa fusa con microstruttura a grafite lamellare austenitica) | | < 180 HB | ≤ 190 | 1.14 | |
| | | | K4.2 | Ghisa malleabile austenitica (ASTM A439 or ASTM A571) (leghe di ghisa fusa con microstruttura a grafite nodulare austenitica) | | < 240 HB | ≤ 740 | 0.86 | |
| | | K4 | K4 | K4.3 | | | < 280 HB | > 840 ≤ 980 | 0.63 |
| | | | | K4.4 | Ghisa sferoidale austemperata (ASTM A897) (leghe di ghisa fusa con microstruttura ausferritica) | | 280 – 320 HB | > 980 ≤ 1130 | 0.54 |
| | | | | K4.5 | | | 320 – 360 HB | > 1130 ≤ 1280 | 0.45 |
| | K5 | K5 | K5.1 | Ghise a grafite compattata CGI (ASTM A842) (ghisa fusa con struttura a grafite vermiculare) | Ferritica | < 180 HB | ≤ 400 | 1.29 | |
| K5.2 | | | | Ferritica-perlitica | 180 – 220 HB | > 400 ≤ 450 | 0.97 | | |
| K5.3 | | | | Perlitica | 220 – 260 HB | > 450 ≤ 500 | 0.75 | | |
| N | N1 | N1.1 | Semilavorato commerciale in puro alluminio | | < 60 HB | ≤ 240 | 1.33 | | |
| | | N1.2 | Leghe di alluminio semilavorata | Semi-temprato | 60 – 100 HB | > 240 ≤ 400 | 1.00 | | |
| | | N1.3 | | Temprato | 100 – 150 HB | > 400 ≤ 590 | 0.67 | | |
| | N2 | N2 | N2.1 | | | < 75 HB | ≤ 240 | 0.67 | |
| | | | N2.2 | Leghe di alluminio pressofuso | | 75 – 90 HB | > 240 ≤ 270 | 0.60 | |
| | | | N2.3 | | | 90 – 140 HB | > 270 ≤ 440 | 0.43 | |
| | N3 | N3 | N3.1 | Leghe di rame con eccellente lavorabilità | | – | – | 0.70 | |
| | | | N3.2 | Leghe di rame a truciolo corto con lavorabilità buona o moderata | | – | – | 0.41 | |
| | | | N3.3 | Rame elettrolitico e leghe di rame a truciolo lungo con lavorabilità da moderata a scarsa | | – | – | 0.21 | |
| | N4 | N4 | N4.1 | Polimeri termoplastici | | – | – | 0.70 | |
| N4.2 | | | Polimeri termoidurenti | | – | – | 0.27 | | |
| N4.3 | | | Polimeri o compositi rinforzati | | – | – | 0.29 | | |
| N5 | N5.1 | Grafite | | – | – | 1.00 | | | |
| S | S1 | S1 | S1.1 | Titanio o leghe di titanio | < 200 HB | ≤ 660 | 1.94 | | |
| | | | S1.2 | | 200 – 280 HB | > 660 ≤ 950 | 1.72 | | |
| | | | S1.3 | | 280 – 360 HB | > 950 ≤ 1200 | 1.44 | | |
| | S2 | S2 | S2.1 | Leghe resistenti al calore a base Fe | < 200 HB | ≤ 690 | 1.33 | | |
| | | | S2.2 | | 200 – 280 HB | > 690 ≤ 970 | 1.17 | | |
| | S3 | S3 | S3.1 | Leghe resistenti al calore a base Ni | < 280 HB | ≤ 940 | 1.00 | | |
| | | | S3.2 | | 280 – 360 HB | > 940 ≤ 1200 | 0.83 | | |
| | S4 | S4 | S4.1 | Leghe resistenti al calore a base Co | < 240 HB | ≤ 800 | 0.78 | | |
| S4.2 | | | | 240 – 320 HB | > 800 ≤ 1070 | 0.67 | | | |
| H | H1 | H1 | H1.1 | Ghisa fusa in conchiglia | < 440 HB | – | 1.52 | | |
| | | | H1.2 | Ghisa temprata | < 55 HRC | – | 0.90 | | |
| | H2 | H2 | H2.1 | | > 55 HRC | – | 0.77 | | |
| | | | H2.2 | | < 51 HRC | – | 1.00 | | |
| | H3 | H3 | H3.1 | Acciaio trattato < 55 HRC | 51 – 55 HRC | – | 0.82 | | |
| | | | H3.2 | | < 55 HRC | – | 0.64 | | |
| | H4 | H4 | H4.1 | Acciaio trattato > 55 HRC | > 59 HRC | – | 0.54 | | |
| | | | H4.2 | | < 55 HRC | – | 0.64 | | |



A large, empty rectangular box with a thin black border, intended for a user to write a note or provide feedback.



SIMPLY RELIABLE

Un professionista può giudicare la qualità del lavoro grazie ad un semplice esame del truciolo. Il nostro truciolo è pulito e di forma semplice e da solo racchiude in se' una storia. Il truciolo è il simbolo perfetto del nostro essere **Simply Reliable**.

DORMER PRAMET

www.dormerpramet.com



**CONTATTI COL
SUPPORTO VENDITE
LOCALE SEMPRE
AGGIORNATI!**



DP-BRO-NEWS-2023.1-IT

FOLLOW US...



ONLINE



SEGMENTS



LIBRARY APP.



CALCULATOR APP.

